

TPS2592Bx 5-V eFuse with Over Voltage Protection and Blocking FET Control

Not Recommended for New Designs

1 Features

- 5-V eFuse, $V_{ABS\text{MAX}} = 20\text{ V}$
- Integrated 28-m Ω Pass MOSFET
- Fixed 6.1-V Over Voltage Clamp
- 2-A to 5-A Adjustable $I_{\text{LIMIT}} (\pm 15\% \text{ Accuracy})$
- Reverse Current Blocking Support
- Programmable OUT Slew Rate, UVLO
- Built-in Thermal Shutdown
- UL 2367 Recognized – File No. 169910*
 - $*R_{\text{ILIM}} \leq 100\text{ k}\Omega$ (4 A max)
- Safe During Single Point Failure Test (UL60950)
- Small Foot Print – 10L (3 mm x 3 mm) VSON

2 Applications

- Adapter Powered Devices
- HDD and SSD Drives
- Set Top Boxes
- Servers / AUX Supplies
- Fan Control
- PCI/PCIe Cards

3 Description

The TPS2592Bx family of eFuses is a highly integrated circuit protection and power management solution in a tiny package. The devices use few external components and provide multiple protection modes. They are a robust defense against overloads, shorts circuits, voltage surges, excessive inrush current, and reverse current.

Current limit level can be set with a single external resistor. Over voltage events are limited by internal clamping circuits to a safe fixed maximum, with no external components required. Applications with particular voltage ramp requirements can set dV/dT with a single capacitor to ensure proper output ramp rates.

Many systems, such as SSDs, must not allow holdup capacitance energy to dump back through the FET body diode onto a drooping or shorted input bus. The BFET pin is for such systems. An external NFET can be connected “Back to Back (B2B)” with the TPS2592 output and the gate driven by BFET to prevent current flow from load to source (see [Figure 42](#)).

Device Information⁽¹⁾

| PART NUMBER | PACKAGE | BODY SIZE (NOM) |
|-------------|-----------|-------------------|
| TPS2592BA | VSON (10) | 3.00 mm x 3.00 mm |
| TPS2592BL | | |

(1) For all available packages, see the orderable addendum at the end of the datasheet.

4 Application Schematic

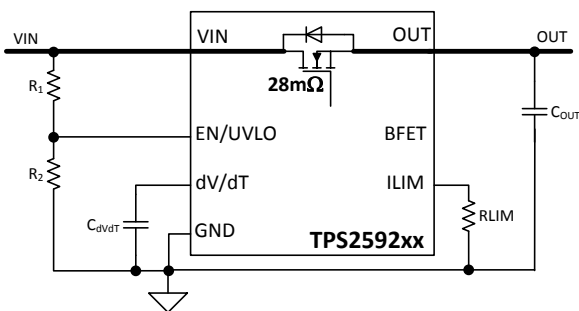

Transient: Output Short Circuit

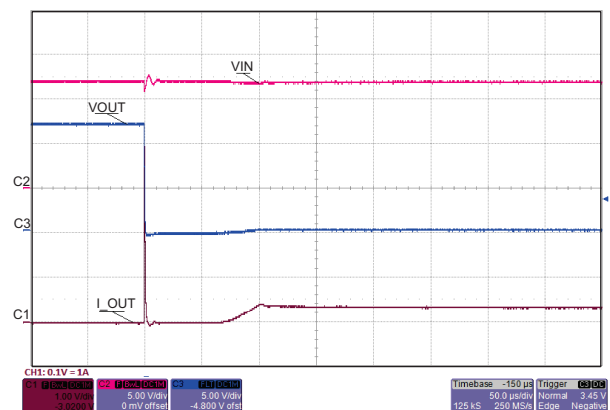

Table of Contents

| | | | | | |
|----------|--|-----------|-----------|---|-----------|
| 1 | Features | 1 | 9.4 | Device Functional Modes | 16 |
| 2 | Applications | 1 | 10 | Application and Implementation | 17 |
| 3 | Description | 1 | 10.1 | Application Information | 17 |
| 4 | Application Schematic | 1 | 10.2 | Typical Applications | 17 |
| 5 | Revision History | 2 | 10.3 | Maximum Device Power Dissipation Considerations | 23 |
| 6 | Device Comparison Table | 3 | 11 | Power Supply Recommendations | 24 |
| 7 | Pin Configuration and Functions | 3 | 11.1 | Transient Protection | 24 |
| 8 | Specifications | 4 | 11.2 | Output Short-Circuit Measurements | 24 |
| 8.1 | Absolute Maximum Ratings | 4 | 12 | Layout | 25 |
| 8.2 | ESD Ratings | 4 | 12.1 | Layout Guidelines | 25 |
| 8.3 | Recommended Operating Conditions | 4 | 12.2 | Layout Example | 25 |
| 8.4 | Thermal Information | 5 | 13 | Device and Documentation Support | 26 |
| 8.5 | Electrical Characteristics | 5 | 13.1 | Device Support | 26 |
| 8.6 | Timing Requirements | 6 | 13.2 | Related Links | 26 |
| 8.7 | Typical Characteristics | 7 | 13.3 | Trademarks | 26 |
| 9 | Detailed Description | 13 | 13.4 | Electrostatic Discharge Caution | 26 |
| 9.1 | Overview | 13 | 13.5 | Glossary | 26 |
| 9.2 | Functional Block Diagram | 13 | 14 | Mechanical, Packaging, and Orderable Information | 26 |
| 9.3 | Feature Description | 13 | | | |

5 Revision History

| DATE | REVISION | NOTES |
|---------------|----------|-----------------|
| December 2014 | * | Initial release |

6 Device Comparison Table

| PART NUMBER | UV | OV CLAMP | FAULT RESPONSE | STATUS |
|-------------|-------|----------|----------------|--------|
| TPS2592BA | 4.3 V | 6.1 V | Auto Retry | Active |
| TPS2592BL | 4.3 V | 6.1 V | Latched | Active |

7 Pin Configuration and Functions

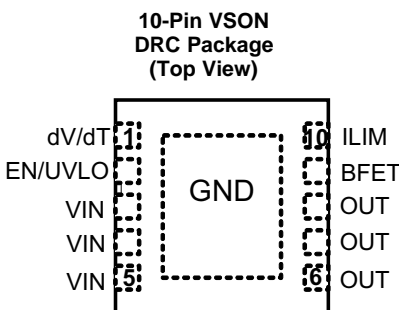

Pin Functions

| PIN | | DESCRIPTION |
|---------|-----------|--|
| NAME | NUMBER | |
| BFET | 9 | Connect this pin to the gate of a blocking NFET. See the Feature Description . |
| dV/dT | 1 | Tie a capacitor from this pin to GND to control the ramp rate of OUT at device turn-on. |
| EN/UVLO | 2 | This is a dual function control pin. When used as an ENABLE pin and pulled down, it shuts off the internal pass MOSFET and pulls BFET to GND. When pulled high, it enables the device and BFET. As an UVLO pin, it can be used to program different UVLO trip point via external resistor divider. |
| GND | PowerPAD™ | GND |
| ILIM | 10 | A resistor from this pin to GND will set the overload and short circuit limit. |
| OUT | 6-8 | Output of the device |
| VIN | 3-5 | Input supply voltage |

8 Specifications

8.1 Absolute Maximum Ratings

over operating temperature range (unless otherwise noted) ⁽¹⁾ ⁽²⁾

| | | MIN | MAX | UNIT |
|--|-----------------------------------|-----------------------------|-----------------------|------|
| Supply voltage range ⁽¹⁾ | V _{IN} | -0.3 | 20 | V |
| | V _{IN} (10 ms Transient) | | 22 | |
| Output voltage | OUT | -0.3 | V _{IN} + 0.3 | V |
| | OUT (Transient < 1 μs) | | -1.2 | V |
| Voltage | ILIM | -0.3 | 7 | V |
| | EN/UVLO | -0.3 | 7 | |
| | dV/dT | -0.3 | 7 | |
| | BFET | -0.3 | 30 | |
| Continuous power dissipation | | See the Thermal Information | | |
| Maximum power dissipation ⁽³⁾ , P _D = (V _{IN} -V _{OUT})*I _{LIMIT} | T _A = -40°C to +85°C | | 40 | W |
| | T _A = 0°C to +85°C | | 50 | |
| Storage temperature range, T _{stg} | | -65 | 150 | °C |

- (1) Stresses beyond those listed under absolute maximum ratings may cause permanent damage to the device. These are stress ratings only and functional operation of the device at these or any conditions beyond those indicated under recommended operating conditions is not implied. Exposure to absolute-maximum-rated conditions for extended periods may affect device reliability.
- (2) All voltage values, except differential voltages, are with respect to network ground terminal.
- (3) Refer to detailed explanation in the application section [Maximum Device Power Dissipation Considerations](#).

8.2 ESD Ratings

| | | | VALUE | UNIT |
|--------------------|-------------------------|--|-------|------|
| V _(ESD) | Electrostatic discharge | Human body model (HBM), per ANSI/ESDA/JEDEC JS-001 ⁽¹⁾ | ±2000 | V |
| | | Charged device model (CDM), per JEDEC specification JESD22-C101 ⁽²⁾ | ±500 | |

- (1) JEDEC document JEP155 states that 500-V HBM allows safe manufacturing with a standard ESD control process.
- (2) JEDEC document JEP157 states that 250-V CDM allows safe manufacturing with a standard ESD control process.

8.3 Recommended Operating Conditions

over operating free-air temperature range (unless otherwise noted)

| | | MIN | TYP | MAX | UNIT |
|--|------------------|-----|-----|--------------------|------|
| Input voltage range | V _{IN} | 4.5 | 5 | 5.5 | V |
| | BFET | 0 | | V _{IN} +6 | |
| | dV/dT, EN/UVLO | 0 | | 6 | |
| | ILIM | 0 | | 3.3 | |
| Continuous output current | I _{OUT} | 0 | | 5 | A |
| Resistance | ILIM | 10 | 100 | 162 | kΩ |
| External capacitance | OUT | 0.1 | 1 | 1000 | μF |
| | dV/dT | | 1 | 1000 | nF |
| Operating junction temperature range, T _J | | -40 | 25 | 125 | °C |
| Operating Ambient temperature range, T _A | | -40 | 25 | 85 | °C |

8.4 Thermal Information⁽¹⁾

over operating free-air temperature range (unless otherwise noted)

| THERMAL METRIC | | TPS2592Bx | UNIT |
|---------------------|--|---------------|------|
| | | DRC (10) PINS | |
| R _{θJA} | Junction-to-ambient thermal resistance | 45.9 | °C/W |
| R _{θJctop} | Junction-to-case (top) thermal resistance | 53 | |
| R _{θJB} | Junction-to-board thermal resistance | 21.2 | |
| Ψ _{JT} | Junction-to-top characterization parameter | 1.2 | |
| Ψ _{JB} | Junction-to-board characterization parameter | 21.4 | |
| R _{θJcbot} | Junction-to-case (bottom) thermal resistance | 5.9 | |

(1) For more information about traditional and new thermal metrics, see the IC Package Thermal Metrics application report, [SPRA953](#).

8.5 Electrical Characteristics

–40°C ≤ T_J ≤ 125°C, V_{IN} = 5 V, V_{EN} /UVLO = 2 V, R_{ILIM} = 100 kΩ, C_{dVdT} = OPEN. All voltages referenced to GND (unless otherwise noted)

| PARAMETER | | TEST CONDITIONS | MIN | TYP | MAX | UNIT |
|---|---|---|------|------|------|------|
| VIN (INPUT SUPPLY) | | | | | | |
| V _{UVR} | UVLO threshold, rising | | 4.15 | 4.3 | 4.45 | V |
| V _{UVhyst} | UVLO hysteresis ⁽¹⁾ | | 5.4% | | | |
| I _{QON} | Supply current | Enabled: EN/UVLO = 2 V | 0.4 | 0.62 | 0.80 | mA |
| I _{QOFF} | | EN/UVLO = 0 V | | 0.1 | 0.25 | mA |
| V _{OVc} | Over-voltage clamp | V _{IN} > 6.75 V, I _{OUT} = 10 mA, –40°C ≤ T _J ≤ 85°C | 5.5 | 6.1 | 6.75 | V |
| | | V _{IN} > 6.75 V, I _{OUT} = 10 mA, –40°C ≤ T _J ≤ 125°C | 5.25 | 6.1 | 6.75 | |
| EN/UVLO (ENABLE/UVLO INPUT) | | | | | | |
| V _{ENR} | EN Threshold voltage, rising | | 1.37 | 1.4 | 1.44 | V |
| V _{ENF} | EN Threshold voltage, falling | | 1.32 | 1.35 | 1.39 | V |
| I _{EN} | EN Input leakage current | 0 V ≤ V _{EN} ≤ 5 V | –100 | 0 | 100 | nA |
| dV/dT (OUTPUT RAMP CONTROL) | | | | | | |
| I _{dVdT} | dV/dT Charging current ⁽¹⁾ | V _{dVdT} = 0 V | | 220 | | nA |
| R _{dVdT_disch} | dV/dT Discharging resistance | EN/UVLO = 0 V, I _{dVdT} = 10 mA sinking | 50 | 73 | 100 | Ω |
| V _{dVdTmax} | dV/dT Max capacitor voltage ⁽¹⁾ | | | 5.5 | | V |
| GAIN _{dVdT} | dV/dT to OUT gain ⁽¹⁾ | ΔV _{dVdT} | | 4.85 | | V/V |
| ILIM (CURRENT LIMIT PROGRAMMING) | | | | | | |
| I _{ILIM} | ILIM Bias current ⁽¹⁾ | | | 10 | | μA |
| I _{OL} | Overload current limit ⁽²⁾ | R _{ILIM} = 45.3 kΩ, V _{VIN-OUT} = 1 V | 1.79 | 2.10 | 2.42 | A |
| | | R _{ILIM} = 100 kΩ, V _{VIN-OUT} = 1 V | 3.46 | 3.75 | 4.03 | |
| | | R _{ILIM} = 150 kΩ, V _{VIN-OUT} = 1 V | 4.4 | 5.2 | 6 | |
| I _{OL-R-Short} | Overload current limit ⁽²⁾ | R _{ILIM} = 0 Ω, Shorted Resistor Current Limit (Single Point Failure Test: UL60950) ⁽¹⁾ | | 0.7 | | A |
| I _{OL-R-Open} | | R _{ILIM} = OPEN, Open Resistor Current Limit (Single Point Failure Test: UL60950) ⁽¹⁾ | | 0.55 | | A |
| I _{SCL} | Short-circuit current limit ⁽²⁾ | R _{ILIM} = 45.3 kΩ, V _{VIN-OUT} = 5 V | 1.72 | 2.05 | 2.38 | A |
| | | R _{ILIM} = 100 kΩ, V _{VIN-OUT} = 5 V | 3.14 | 3.56 | 3.98 | |
| | | R _{ILIM} = 150 kΩ, V _{VIN-OUT} = 5 V | 4.12 | 4.86 | 5.60 | |
| RATIO _{FASTRIP} | Fast-Trip comparator level w.r.t. overload current limit ⁽¹⁾ | I _{FASTRIP} : I _{OL} | | 160% | | |
| V _{OpenILIM} | ILIM Open resistor detect threshold ⁽¹⁾ | V _{ILIM} Rising, R _{ILIM} = OPEN | | 3.1 | | V |

(1) These parameters are provided for reference only and do not constitute part of TI's published device specifications for purposes of TI's product warranty.

(2) Pulsed testing techniques used during this test maintain junction temperature approximately equal to ambient temperature.

TPS2592BA, TPS2592BL

SLVSCU2 – DECEMBER 2014

www.ti.com

Electrical Characteristics (continued)

–40°C ≤ T_J ≤ 125°C, V_{IN} = 5 V, V_{EN /UVLO} = 2 V, R_{ILIM} = 100 kΩ, C_{dVdT} = OPEN. All voltages referenced to GND (unless otherwise noted)

| PARAMETER | | TEST CONDITIONS | MIN | TYP | MAX | UNIT |
|--|--------------------------------------|--|------------|------------------------|-----|------|
| OUT (PASS FET OUTPUT) | | | | | | |
| R _{DS(on)} | FET ON resistance | T _J = 25°C | 21 | 28 | 33 | mΩ |
| | | T _J = 125°C | | 39 | 46 | |
| I _{OUT-OFF-LKG} | OUT Bias current in off state | V _{EN/UVLO} = 0 V, V _{OUT} = 0 V (Sourcing) | –5 | 0 | 1 | μA |
| I _{OUT-OFF-SINK} | | V _{EN/UVLO} = 0V, V _{OUT} = 300 mV (Sinking) | 10 | 15 | 20 | |
| BFET (BLOCKING FET GATE DRIVER) | | | | | | |
| I _{BFET} | BFET Charging current ⁽¹⁾ | V _{BFET} = V _{OUT} | | 2 | | μA |
| V _{BFETmax} | BFET Clamp voltage ⁽¹⁾ | | | V _{VIN} + 6.4 | | V |
| R _{BFETdisch} | BFET Discharging resistance to GND | V _{EN/UVLO} = 0 V, I _{BFET} = 100 mA | 15 | 26 | 36 | Ω |
| TSD (THERMAL SHUT DOWN) | | | | | | |
| T _{SHDN} | TSD Threshold, rising ⁽¹⁾ | | | 160 | | °C |
| T _{SHDNhyst} | TSD Hysteresis ⁽¹⁾ | | | 10 | | °C |
| | Thermal fault: latched or autoretry | TPS2592BL | LATCHED | | | |
| | | TPS2592BA | AUTO-RETRY | | | |

8.6 Timing Requirements

| PARAMETER | | TEST CONDITIONS | MIN | TYP | MAX | UNIT |
|---|---|---|------|-----|------|------|
| T _{ON} | Turn-on delay ⁽¹⁾ | EN/UVLO → H to I _{VIN} = 100 mA, 1-A resistive load at OUT | | 220 | | μs |
| t _{OFFdly} | Turn Off delay ⁽²⁾ | EN↓ to BFET↓, C _{BFET} = 0 | | 0.4 | | μs |
| dV/dT (OUTPUT RAMP CONTROL) | | | | | | |
| t _{dVdT} | Output ramp time | EN/UVLO → H to OUT = 4.9 V, C _{dVdT} = 0 | 0.28 | 0.4 | 0.52 | ms |
| | | EN/UVLO → H to OUT = 4.9 V, C _{dVdT} = 1 nF ⁽²⁾ | | 5 | | |
| ILIM (CURRENT LIMIT PROGRAMMING) | | | | | | |
| t _{FastOffDly} | Fast-Trip comparator delay ⁽²⁾ | I _{OUT} > I _{FASTTRIP} to I _{OUT} = 0 (Switch Off) | | 3 | | μs |
| BFET (BLOCKING FET GATE DRIVER) | | | | | | |
| t _{BFET-ON} | BFET Turn-On duration ⁽²⁾ | EN/UVLO → H to V _{BFET} = 12 V, C _{BFET} = 1 nF | | 4.2 | | ms |
| | | EN/UVLO → H to V _{BFET} = 12 V, C _{BFET} = 10 nF | | 42 | | |
| t _{BFET-OFF} | BFET Turn-Off duration ⁽²⁾ | EN/UVLO → L to V _{BFET} = 1 V, C _{BFET} = 1 nF | | 0.4 | | μs |
| | | EN/UVLO → L to V _{BFET} = 1 V, C _{BFET} = 10 nF | | 1.4 | | |

(1) These parameters are provided for reference only and do not constitute part of TI's published device specifications for purposes of TI's product warranty.

(2) These parameters are provided for reference only and do not constitute part of TI's published device specifications for purposes of TI's product warranty.

8.7 Typical Characteristics

$T_J = 25^\circ\text{C}$, $V_{VIN} = 5\text{ V}$, $V_{EN/UVLO} = 2\text{ V}$, $R_{ILIM} = 100\text{ k}\Omega$, $C_{VIN} = 0.1\text{ }\mu\text{F}$, $C_{OUT} = 1\text{ }\mu\text{F}$, $C_{dVdT} = \text{OPEN}$ (unless stated otherwise)

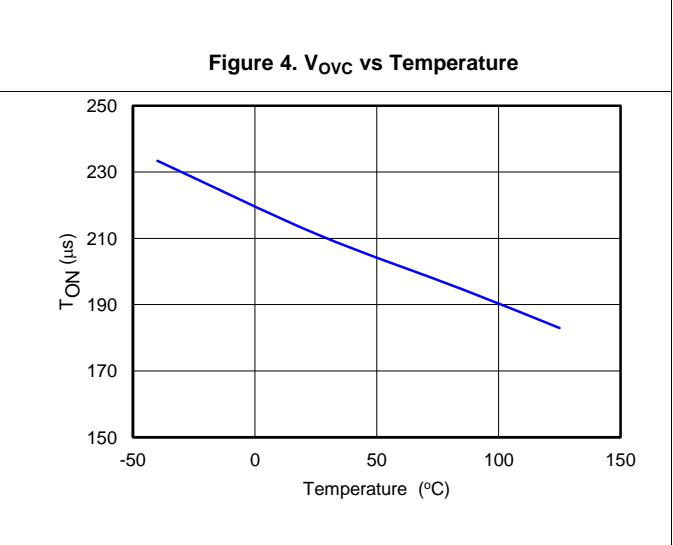
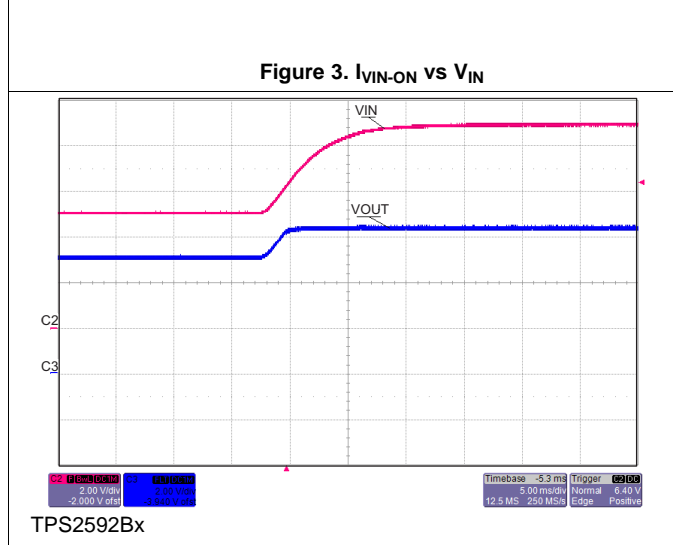
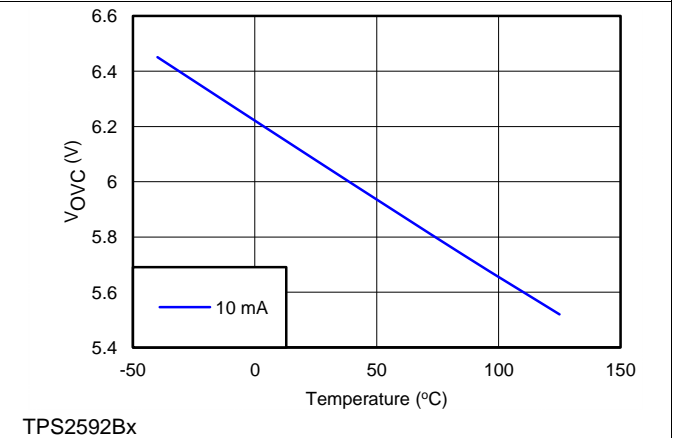
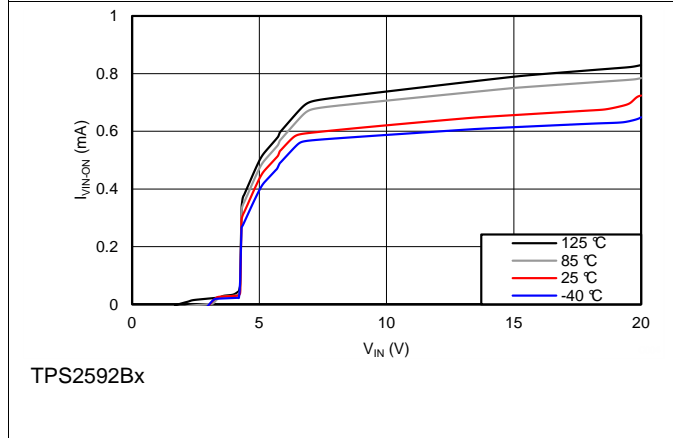
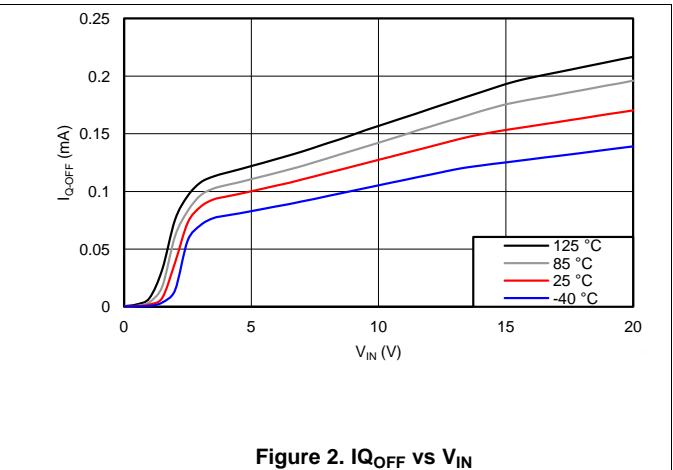
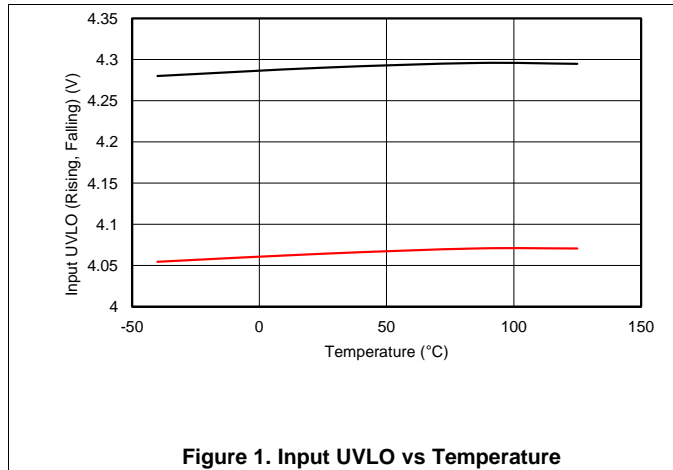

Typical Characteristics (continued)

$T_J = 25^\circ\text{C}$, $V_{VIN} = 5\text{ V}$, $V_{EN/UVLO} = 2\text{ V}$, $R_{ILIM} = 100\text{ k}\Omega$, $C_{VIN} = 0.1\text{ }\mu\text{F}$, $C_{OUT} = 1\text{ }\mu\text{F}$, $C_{dVdT} = \text{OPEN}$ (unless stated otherwise)

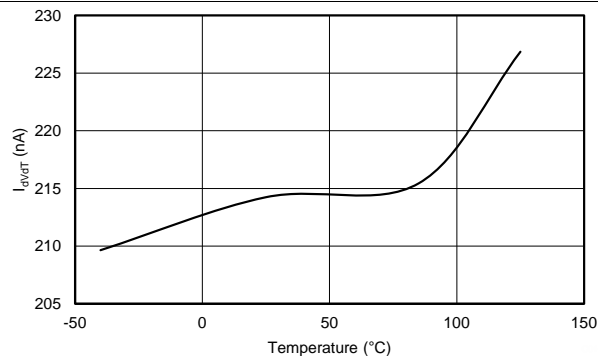
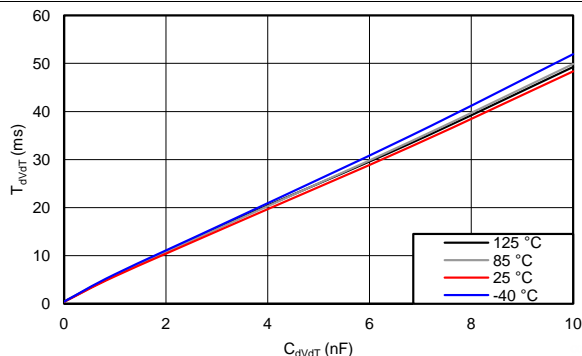

Figure 7. I_{dVdT} vs Temperature



TPS2592Bx

Figure 8. T_{dVdT} vs C_{dVdT}

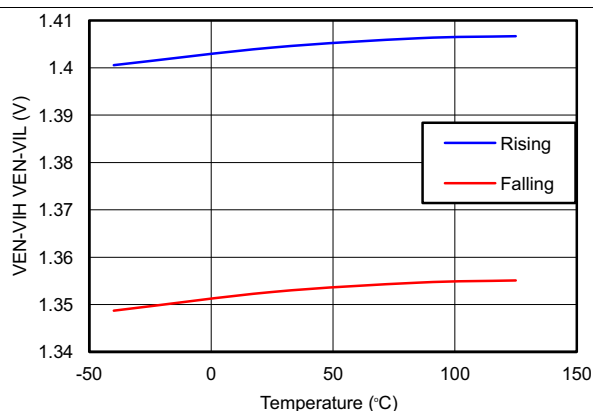

Figure 9. V_{EN_VIH} , V_{EN_VIL} vs Temperature

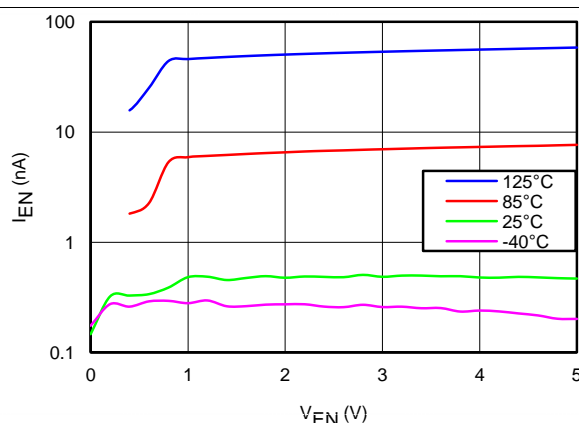
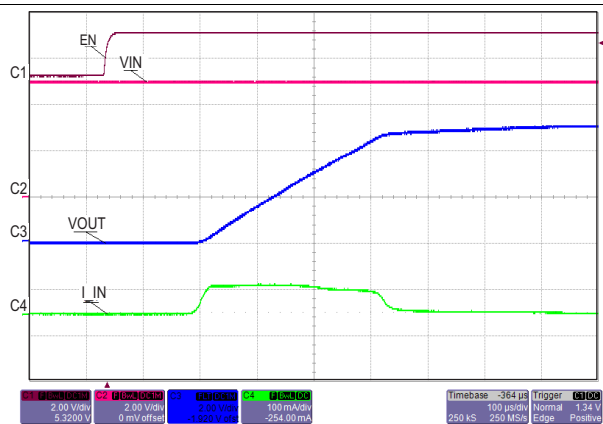
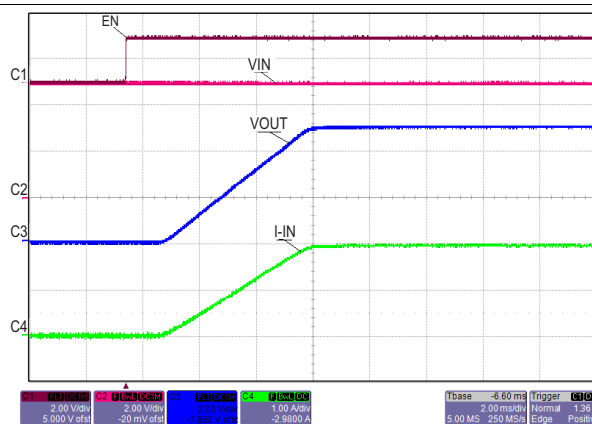

Figure 10. I_{EN} (Leakage Current) vs V_{EN}



TPS2592Bx, $C_{dVdT} = \text{OPEN}$, $C_{OUT} = 4.7\text{ }\mu\text{F}$

Figure 11. Transient: Output Ramp



TPS2592Bx, $C_{dVdT} = 1\text{ nF}$, $C_{OUT} = 10\text{ }\mu\text{F}$, $R_{OUT} = 2.5\text{ }\Omega$

Figure 12. Transient Output Ramp

Typical Characteristics (continued)

$T_J = 25^\circ\text{C}$, $V_{VIN} = 5\text{ V}$, $V_{EN/UVLO} = 2\text{ V}$, $R_{LIM} = 100\text{ k}\Omega$, $C_{VIN} = 0.1\text{ }\mu\text{F}$, $C_{OUT} = 1\text{ }\mu\text{F}$, $C_{dVdT} = \text{OPEN}$ (unless stated otherwise)

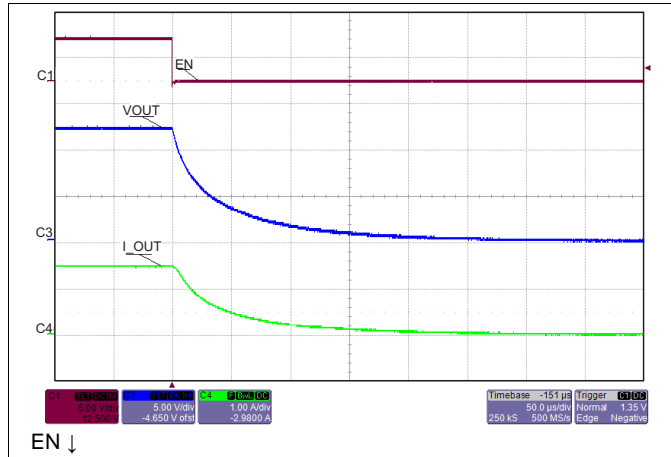

Figure 13. Transient: Turn Off Delay

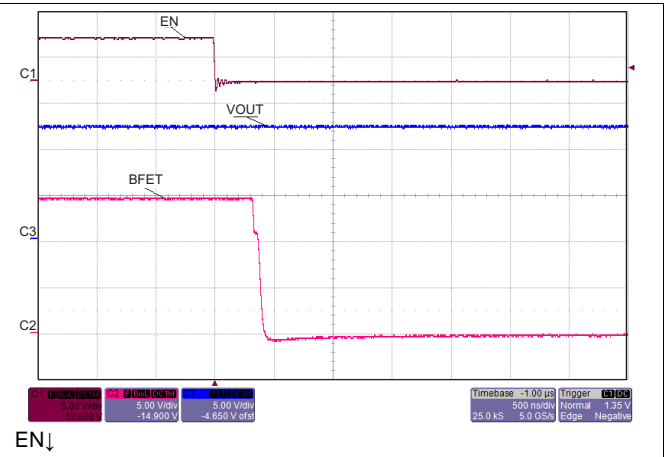

Figure 14. Turn Off Delay to BFET

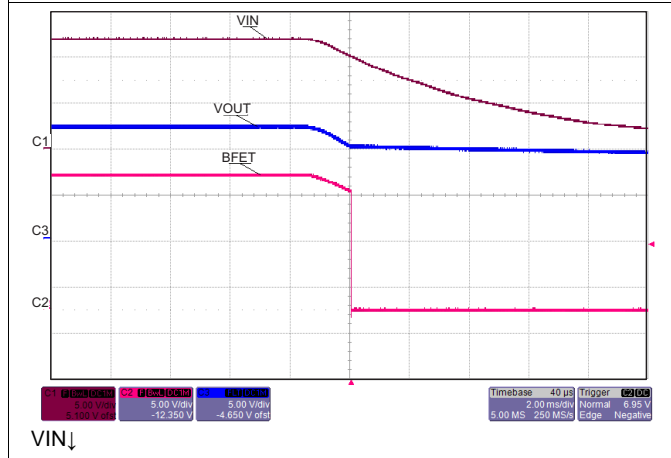

Figure 15. Turn Off Delay to BFET

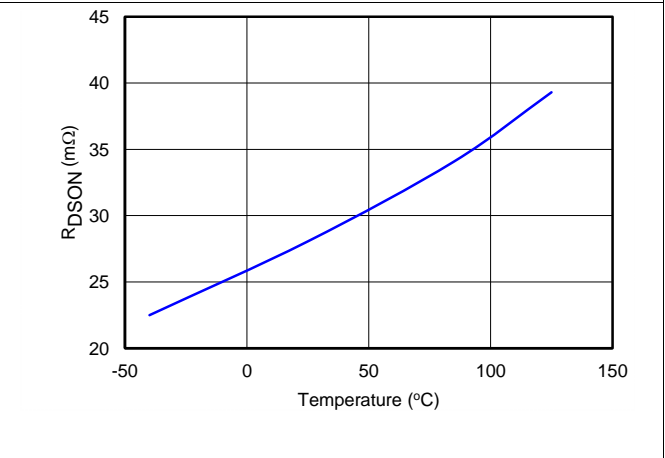

Figure 16. $R_{DS(on)}$ vs Temperature

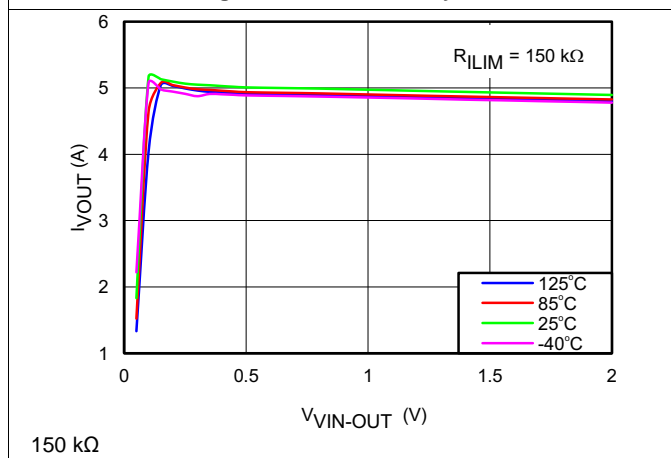

Figure 17. I_{OUT} vs $V_{VIN-OUT}$

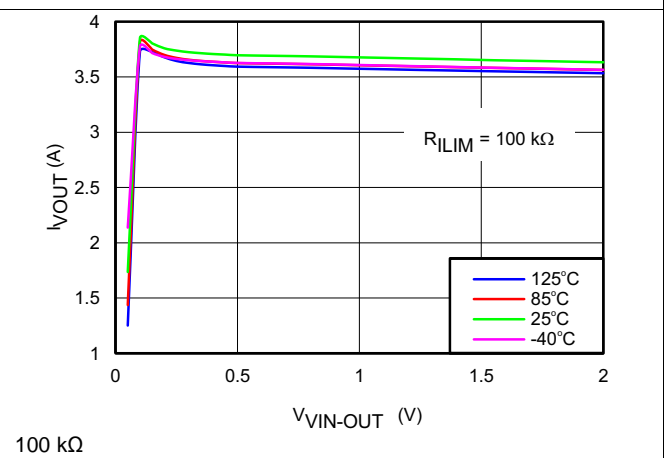
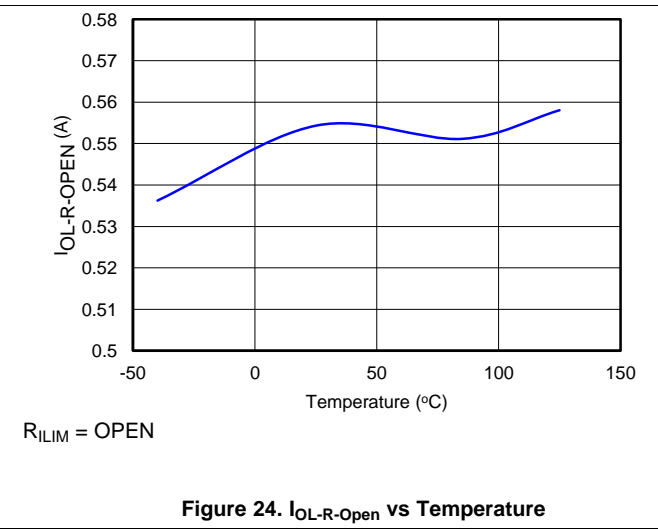
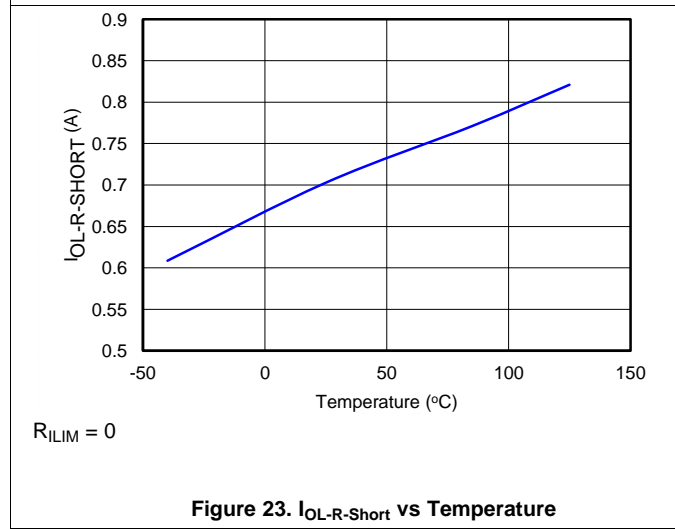
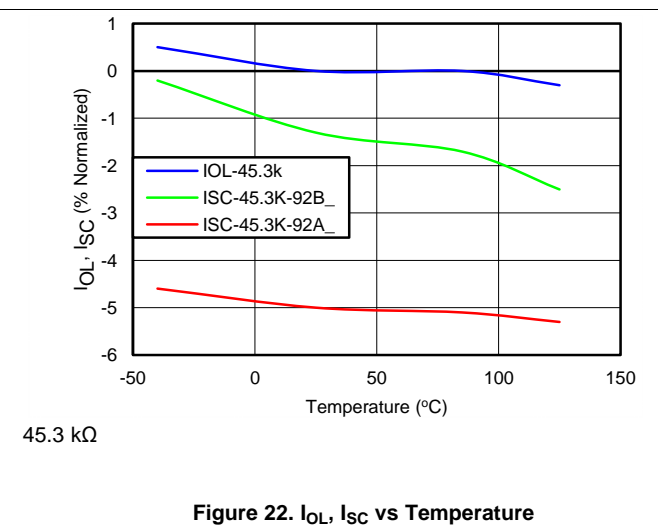
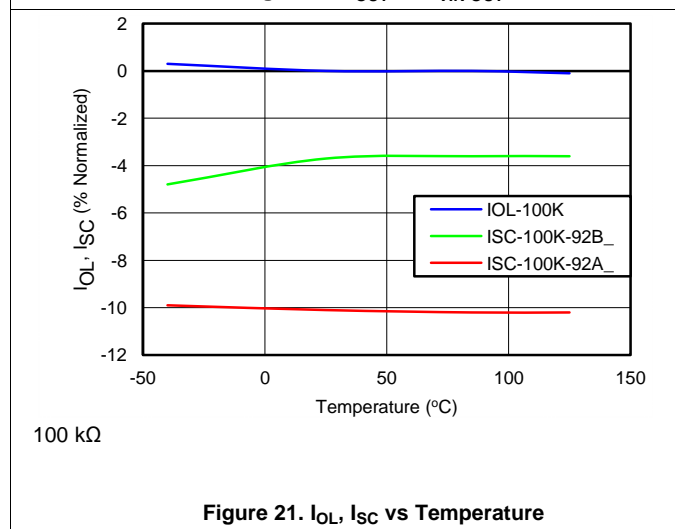
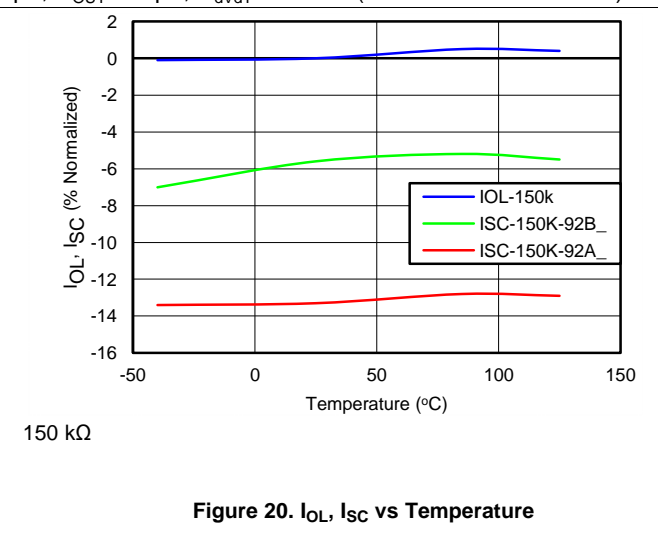
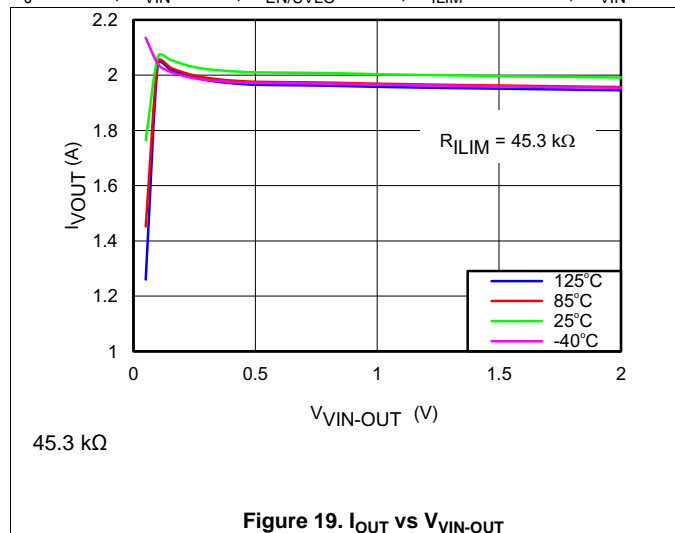

Figure 18. I_{OUT} vs $V_{VIN-OUT}$

Typical Characteristics (continued)

$T_J = 25^\circ\text{C}$, $V_{VIN} = 5\text{ V}$, $V_{EN/UVLO} = 2\text{ V}$, $R_{ILIM} = 100\text{ k}\Omega$, $C_{VIN} = 0.1\text{ }\mu\text{F}$, $C_{OUT} = 1\text{ }\mu\text{F}$, $C_{dVdT} = \text{OPEN}$ (unless stated otherwise)



Typical Characteristics (continued)

$T_J = 25^\circ\text{C}$, $V_{VIN} = 5\text{ V}$, $V_{EN/UVLO} = 2\text{ V}$, $R_{ILIM} = 100\text{ k}\Omega$, $C_{VIN} = 0.1\text{ }\mu\text{F}$, $C_{OUT} = 1\text{ }\mu\text{F}$, $C_{dVdT} = \text{OPEN}$ (unless stated otherwise)

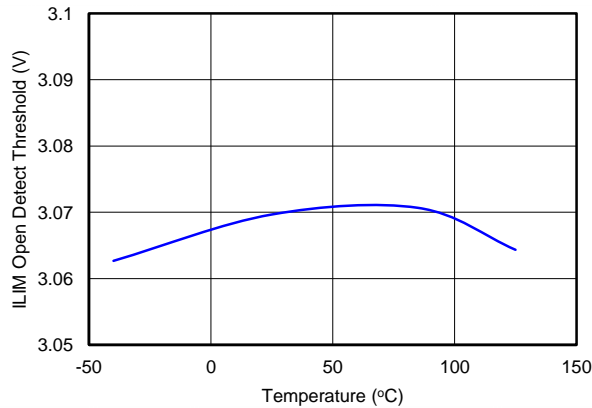

Figure 25. $V_{OpenLIM}$ vs Temperature

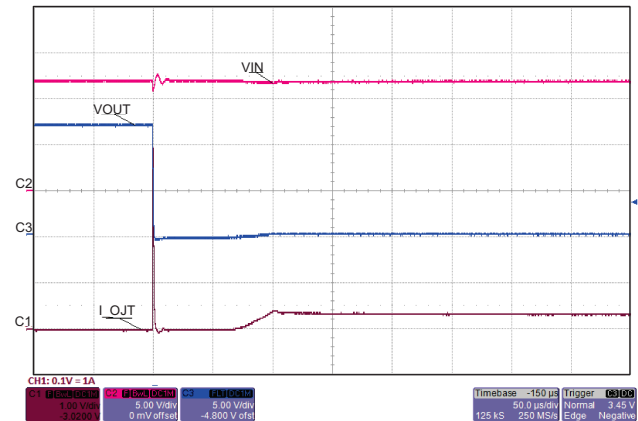

Figure 26. Transient: Output Short Circuit

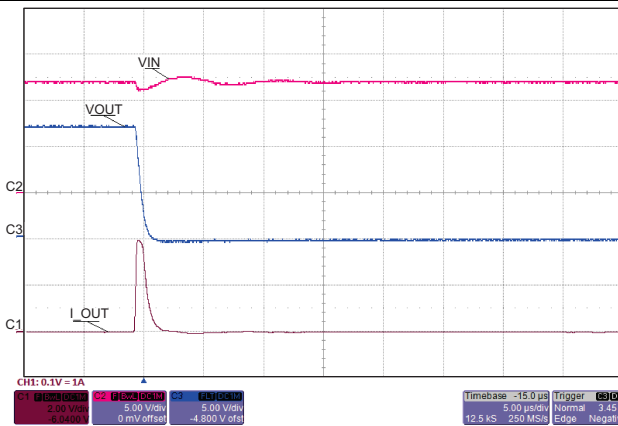

Figure 27. Short Circuit (Zoom): Fast-Trip Comparator

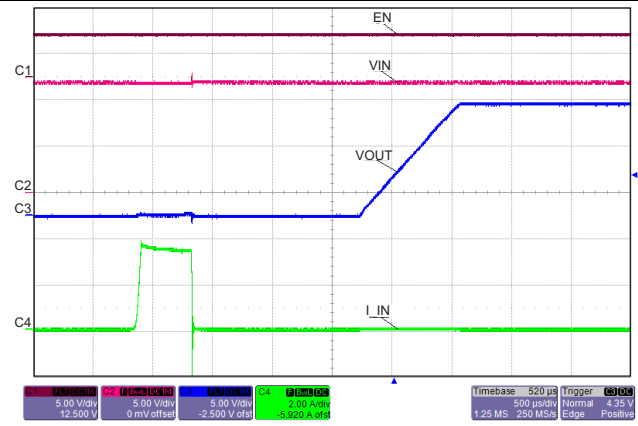

Figure 28. Transient: Recovery From Short Circuit / Over Current

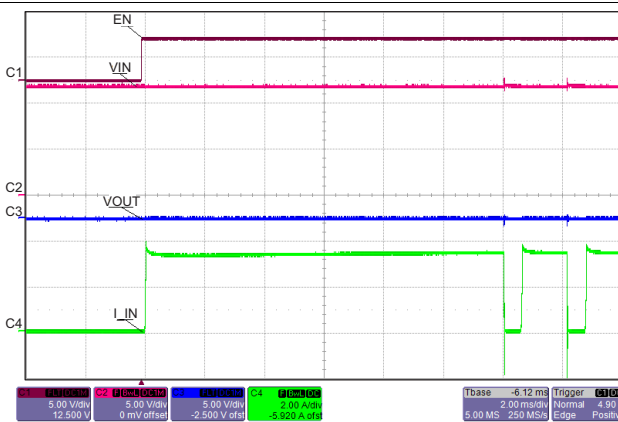
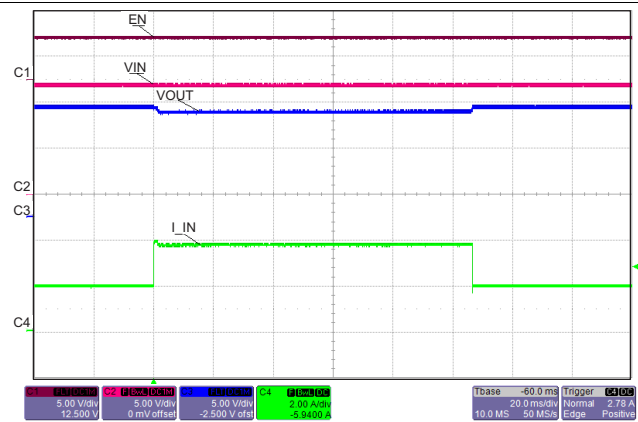

Figure 29. Transient: Wake Up to Short Circuit



I_{LOAD} Stepped From 50% to 120%, back to 50%

Figure 30. Transient: Overload Current Limit

TPS2592BA, TPS2592BL

SLVSCU2 – DECEMBER 2014

www.ti.com

Typical Characteristics (continued)

$T_J = 25^\circ\text{C}$, $V_{VIN} = 5\text{ V}$, $V_{EN/UVLO} = 2\text{ V}$, $R_{ILIM} = 100\text{ k}\Omega$, $C_{VIN} = 0.1\text{ }\mu\text{F}$, $C_{OUT} = 1\text{ }\mu\text{F}$, $C_{dVdT} = \text{OPEN}$ (unless stated otherwise)

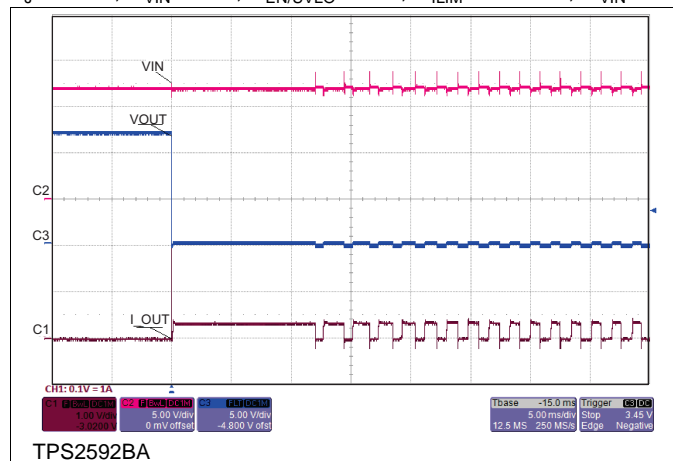

Figure 31. Transient: Thermal Fault Auto-Retry

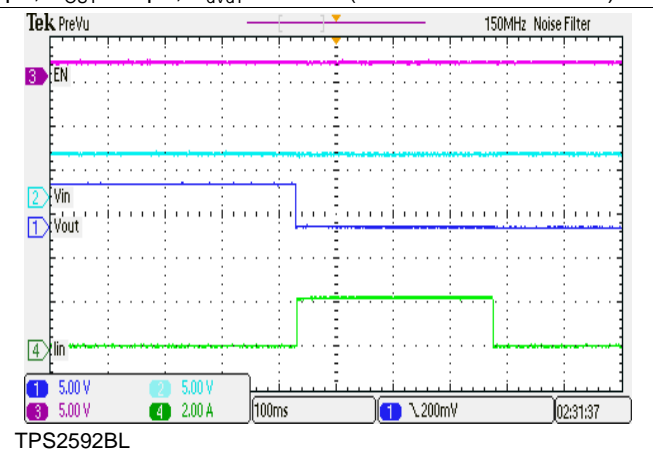

Figure 32. Transient: Thermal Fault Latched

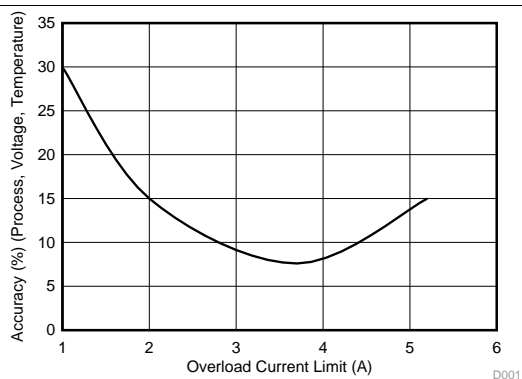

Figure 33. Accuracy vs Overload Current Limit

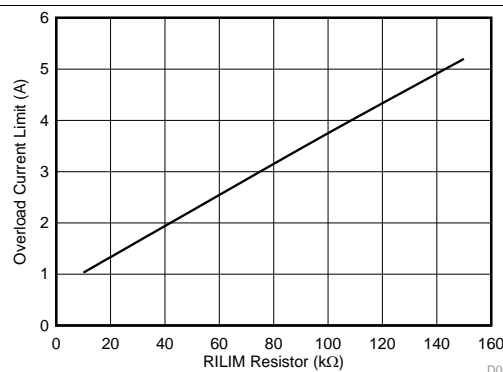

Figure 34. Overload Current Limit vs R_{ILIM}

9 Detailed Description

9.1 Overview

The TPS2592xx is an e-fuse with integrated power switch that is used to manage current/voltage/start-up voltage ramp to a connected load. The device starts its operation by monitoring the VIN bus. When VIN exceeds the undervoltage-lockout threshold (VUVR), the device samples the EN/UVLO pin. A high level on this pin enables the internal MOSFET. As VIN rises, the internal MOSFET of the device will start conducting and allow current to flow from VIN to OUT. When EN/UVLO is held low (below VENF), internal MOSFET is turned off. User also has the ability to modify the output voltage ramp time by connecting a capacitor between dV/dT pin and GND.

After a successful start-up sequence, the device now actively monitors its load current and input voltage, ensuring that the adjustable overload current limit I_{OL} is not exceeded and input voltage spikes are safely clamped to V_{OVC} level at the output. This keeps the output device safe from harmful voltage and current transients. The device also has built-in thermal sensor. In the event device temperature (T_J) exceeds T_{SHDN} , typically 160°C, the thermal shutdown circuitry will shut down the internal MOSFET thereby disconnecting the load from the supply. In TPS2592xL, the output will remain disconnected (MOSFET open) until power to device is recycled or EN/UVLO is toggled (pulled low and then high). The TPS2592xA device will remain off during a cooling period until device temperature falls below $T_{SHDN} - 10^\circ\text{C}$, after which it will attempt to restart. This ON and OFF cycle will continue until fault is cleared.

9.2 Functional Block Diagram

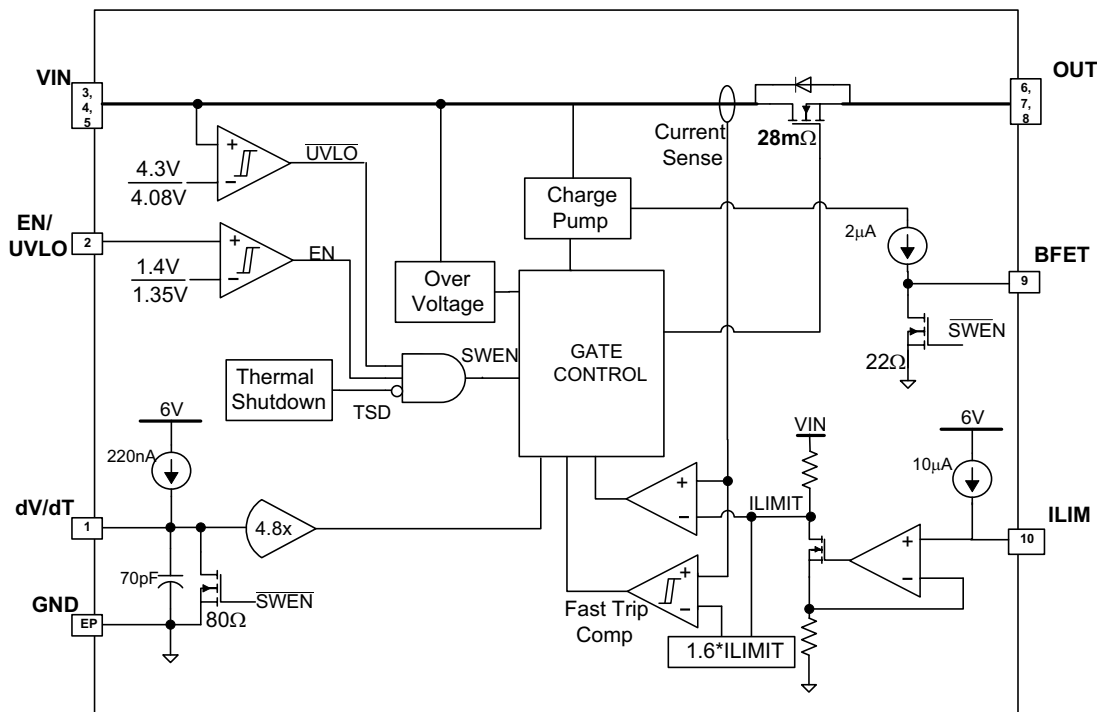

9.3 Feature Description

9.3.1 GND

This is the most negative voltage in the circuit and is used as a reference for all voltage measurements unless otherwise specified.

Feature Description (continued)

9.3.2 VIN

Input voltage to the TPS2592Bx. A ceramic bypass capacitor close to the device from VIN to GND is recommended to alleviate bus transients. The recommended operating voltage range is 4.5 V to 5.5 V for TPS2592Bx. The device can continuously sustain a voltage of 20 V on VIN pin. However, above the recommended maximum bus voltage, the device will be in over-voltage protection (OVP) mode, limiting the output voltage to V_{OVC} . The power dissipation in OVP mode is $P_{D_OVP} = (V_{VIN} - V_{OVC}) \times I_{OUT}$, which can potentially heat up the device and cause thermal shutdown.

9.3.3 dV/dT

Connect a capacitor from this pin to GND to control the slew rate of the output voltage at power-on. This pin can be left floating to obtain a predetermined slew rate (minimum T_{dVdT}) on the output. Equation governing slew rate at start-up is shown below:

$$\frac{dV_{OUT}}{dt} = \frac{I_{dVdT} \times GAIN_{dVdT}}{C_{dVdT} + C_{INT}} \quad (1)$$

Where:

$$I_{dVdT} = 220 \text{ nA (TYP)}$$

$$C_{INT} = 70 \text{ pF (TYP)}$$

$$GAIN_{dVdT} = 4.85$$

$$\frac{dV_{OUT}}{dT} = \text{Desired output slew rate}$$

The total ramp time (T_{dVdT}) for 0 to VIN can be calculated using the following equation:

$$T_{dVdT} = 10^6 \times V_{IN} \times (C_{dVdT} + 70 \text{ pF}) \quad (2)$$

For details on how to select an appropriate charging time/rate, refer to the applications section: [Setting Output Voltage Ramp Time \(\$T_{dVdT}\$ \)](#)

9.3.4 BFET

Connect this pin to an external NFET that can be used to disconnect input supply from rest of the system in the event of power failure at VIN. The BFET pin is controlled by either UVLO event or EN/UVLO (see [Table 1](#)). BFET can source charging current of 2 μA (TYP) and sink (discharge) current from the gate of the external FET via a 26- Ω internal discharge resistor to initiate fast turn-off, typically <1 μs . Due to 2 μA charging current, it is recommended to use >10 M Ω impedance when probing the BFET node.

Table 1.

| EN/UVLO > V_{ENR} | VIN > V_{UVR} | BFET MODE |
|---------------------|-----------------|-----------|
| H | H | Charge |
| X | L | Discharge |
| L | X | Discharge |

9.3.5 EN/UVLO

As an input pin, it controls both the ON/OFF state of the internal MOSFET and that of the external blocking FET. In its high state, the internal MOSFET is enabled and charging begins for the gate of external FET. A low on this pin will turn off the internal MOSFET and pull the gate of the external FET to GND via the built-in discharge resistor. High and Low levels are specified in the parametric table of the datasheet. The EN/UVLO pin is also used to clear a thermal shutdown latch in the TPS2592xL by toggling this pin (H→L).

The internal de-glitch delay on EN/UVLO falling edge is intentionally kept low (1 μs typical) for quick detection of power failure. When used with a resistor divider from supply to EN/UVLO to GND, power-fail detection on EN/UVLO helps in quick turn-off of the BFET driver, thereby stopping the flow of reverse current (see typical application diagram, [Figure 42](#)). For applications where a higher de-glitch delay on EN/UVLO is desired, or when the supply is particularly noisy, it is recommended to use an external bypass capacitor from EN/UVLO to GND.

9.3.6 ILIM

The device continuously monitors the load current and keeps it limited to the value programmed by R_{ILIM} . After start-up event and during normal operation, current limit is set to I_{OL} (over-load current limit).

$$I_{OL} = (0.7 + 3 \times 10^{-5} \times R_{ILIM}) \tag{3}$$

When power dissipation in the internal MOSFET [$P_D = (V_{VIN} - V_{OUT}) \times I_{OUT}$] exceeds 10 W, there is a 2% – 12% thermal foldback in the current limit value so that I_{OL} drops to I_{SC} . In each of the two modes, MOSFET gate voltage is regulated to throttle short-circuit and overload current flowing to the load. Eventually, the device shuts down due to over temperature.

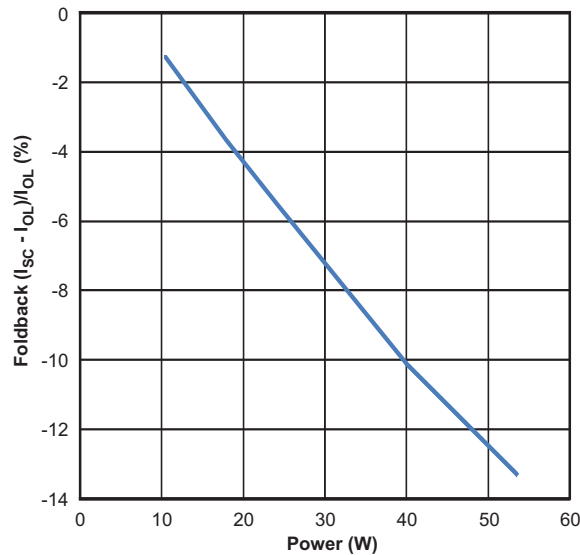

Figure 35. Thermal Foldback in Current Limit

During a transient short circuit event, the current through the device increases very rapidly. The current-limit amplifier cannot respond very quickly to this event due to its limited bandwidth. Therefore, the TPS2592 incorporates a fast-trip comparator, which shuts down the pass device very quickly when $I_{OUT} > I_{FASTRIP}$, and terminates the rapid short-circuit peak current. The trip threshold is set to 60% higher than the programmed over-load current limit ($I_{FASTRIP} = 1.6 \times I_{OL}$). After the transient short-circuit peak current has been terminated by the fast-trip comparator, the current limit amplifier smoothly regulates the output current to I_{OL} (see figure below).

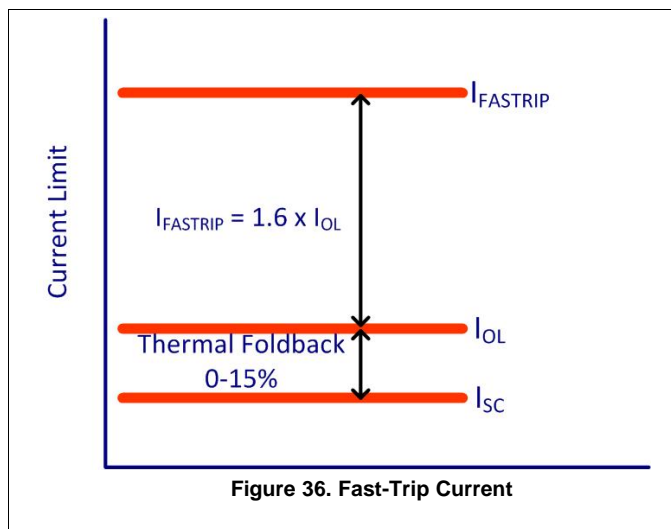

Figure 36. Fast-Trip Current

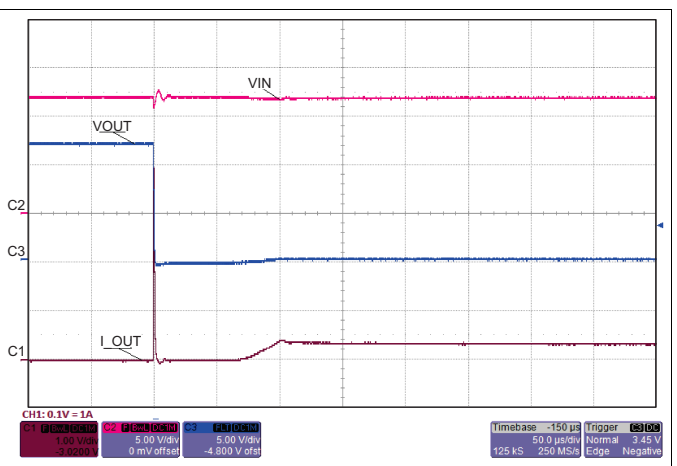

Figure 37. Fast-Trip and Current Limit Amplifier Response for Short Circuit

9.4 Device Functional Modes

The TPS2592xx is a hot-swap controller with integrated power switch that is used to manage current/voltage/start-up voltage ramp to a connected load. The device starts its operation by monitoring the VIN bus. When V_{VIN} exceeds the undervoltage-lockout threshold (V_{UVL}), the device samples the EN/UVLO pin. A high level on this pin enables the internal MOSFET and also start charging the gate of external blocking FET (if connected) via the BFET pin. As VIN rises, the internal MOSFET of the device and external FET (if connected) will start conducting and allow current to flow from VIN to OUT. When EN/UVLO is held low (that is, below V_{ENF}), the internal MOSFET is turned off and BFET pin is discharged, thereby, blocking the flow of current from VIN to OUT. User also has the ability to modify the output voltage ramp time by connecting a capacitor between dV/dT pin and GND.

Having successfully completed its start-up sequence, the device now actively monitors its load current and input voltage, ensuring that the adjustable overload current limit I_{OL} is not exceeded and input voltage spikes are safely clamped to V_{OVC} level at the output. This keeps the output device safe from harmful voltage and current transients. The device also has built-in thermal sensor. In the event device temperature (T_J) exceeds T_{SHDN} , typically 160°C, the thermal shutdown circuitry will shut down the internal MOSFET thereby disconnecting the load from the supply. In the TPS2592xL, the output will remain disconnected (MOSFET open) until power to device is recycled or EN/UVLO is toggled (pulled low and then high). The TPS2592xA device will remain off during a cooling period until device temperature falls below $T_{SHDN} - 10^\circ\text{C}$, after which it will attempt to restart. This ON and OFF cycle will continue until fault is cleared.

10 Application and Implementation

NOTE

Information in the following applications sections is not part of the TI component specification, and TI does not warrant its accuracy or completeness. TI's customers are responsible for determining suitability of components for their purposes. Customers should validate and test their design implementation to confirm system functionality.

10.1 Application Information

The TPA2592xx is a smart eFuse. It is typically used for Hot-Swap and Power rail protection applications. It operates from 4.5 V to 18 V with programmable current limit and undervoltage protection. The device aids in controlling the in-rush current and provides precise current limiting during overload conditions for systems such as Set-Top-Box, DTVs, Gaming Consoles, SSDs/HDDs and Smart Meters. The device also provides robust protection for multiple faults on the sub-system rail.

The following design procedure can be used to select component values for the device. Alternatively, the WEBENCH® software may be used to generate a complete design. The WEBENCH® software uses an iterative design procedure and accesses a comprehensive database of components when generating a design. Additionally, a spreadsheet design tool [TPS2592 Design Calculator \(SLUC571\)](#) is available on web folder. This section presents a simplified discussion of the design process.

10.2 Typical Applications

10.2.1 Simple 3.7-A eFuse Protection for Set Top Boxes

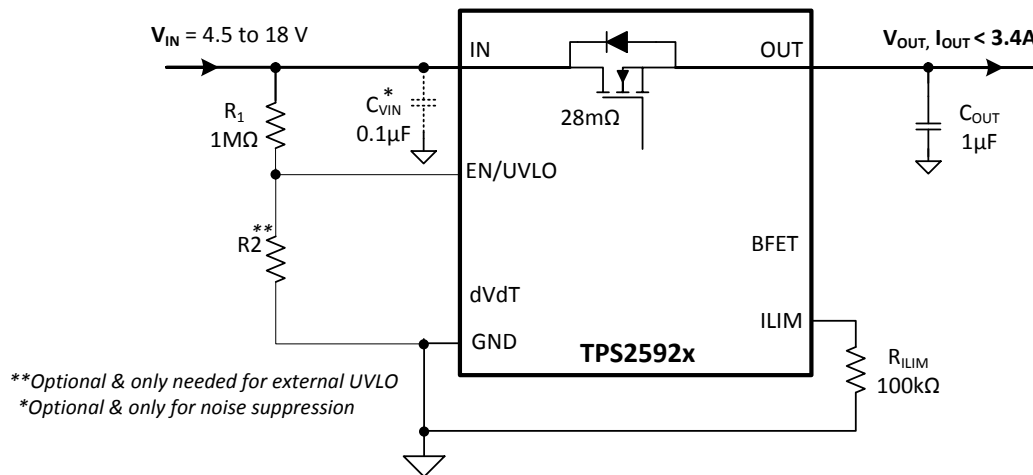

Figure 38. Typical Application Schematic: Simple 3.7-A e-Fuse for STBs

10.2.1.1 Design Requirements

Table 2. Design Parameters

| DESIGN PARAMETER | EXAMPLE VALUE |
|--|----------------------------|
| Input voltage range, V_{IN} | 5 V |
| Undervoltage lockout set point, $V_{(UV)}$ | Default: $V_{UVR} = 4.3$ V |
| Overvoltage protection set point, $V_{(OV)}$ | Default: $V_{OVC} = 6.1$ V |
| Load at Start-Up, $R_{L(SU)}$ | 2 Ω |
| Current limit, $I_{OL} = I_{LIM}$ | 3.7 A |
| Load capacitance, C_{OUT} | 1 μ F |
| Maximum ambient temperatures, T_A | 85°C |

10.2.1.2 Detailed Design Procedure

The following design procedure can be used to select component values for the TPS2592xx.

10.2.1.2.1 Step by Step Design Procedure

This design procedure below seeks to control the junction temperature of device under both static and transient conditions by proper selection of output ramp-up time and associated support components. The designer can adjust this procedure to fit the application and design criteria.

10.2.1.2.2 Programming the Current-Limit Threshold: R_{ILIM} Selection

The R_{ILIM} resistor at the ILIM pin sets the over load current limit, this can be set using [Equation 4](#).

$$R_{ILIM} = \frac{I_{ILIM} - 0.7}{3 \times 10^{-5}} \quad (4)$$

For $I_{OL} = I_{ILIM} = 3.7$ A, from equation 4, $R_{ILIM} = 100$ k Ω . Choose closest standard value resistor with 1% tolerance.

10.2.1.2.3 Undervoltage Lockout Set Point

The undervoltage lockout (UVLO) trip point is adjusted using the external voltage divider network of R_1 and R_2 as connected between IN, EN/UVLO and GND pins of the device. The values required for setting the undervoltage are calculated solving [Equation 5](#).

$$V_{(UV)} = \frac{R_1 + R_2}{R_2} \times V_{ENR} \quad (5)$$

Where $V_{ENR} = 1.4$ V, is enable voltage rising threshold.

Since R_1 and R_2 will leak the current from input supply (V_{IN}), these resistors should be selected based on the acceptable leakage current from input power supply (V_{IN}). The current drawn by R_1 and R_2 from the power supply $\{I_{R12} = V_{IN}/(R_1 + R_2)\}$.

However, leakage currents due to external active components connected to the resistor string can add error to these calculations. So, the resistor string current, I_{R12} must be chosen to be 20x greater than the leakage current expected.

For default UVLO of $V_{UVR} = 4.3$ V, select $R_2 = OPEN$, and $R_1 = 1$ M Ω . Since EN/UVLO pin is rated only to 7 V, it cannot be connected directly to $V_{IN} > 7$ V. It has to be connected through $R_1 = 1$ M Ω only, so that the pull-up current for EN/UVLO pin is limited to < 20 μ A.

The power failure threshold is detected on the falling edge of supply. This threshold voltage is 4% lower than the rising threshold, V_{UVR} . This is calculated using [Equation 6](#).

$$V_{(PFAIL)} = 0.96 \times V_{UVR} \quad (6)$$

Where V_{UVR} is 4.3V, Power fail threshold set is : $V_{(PFAIL)} = 4.1$ V

10.2.1.2.4 Setting Output Voltage Ramp Time (T_{dVdT})

For a successful design, the junction temperature of device should be kept below the absolute-maximum rating during both dynamic (start-up) and steady state conditions. Dynamic power stresses often are an order of magnitude greater than the static stresses, so it is important to determine the right start-up time and in-rush current limit required with system capacitance to avoid thermal shutdown during start-up with and without load.

The ramp-up capacitor C_{dVdT} needed is calculated considering the two possible cases:

10.2.1.2.4.1 Case 1: Start-up without Load: Only Output Capacitance C_{OUT} Draws Current During Start-up

During start-up, as the output capacitor charges, the voltage difference as well as the power dissipated across the internal FET decreases. The average power dissipated in the device during start-up is calculated using [Equation 8](#).

For TPS2592xx, the inrush current is determined as,

$$I_{(INRUSH)} = C_{(OUT)} \times \frac{V_{(IN)}}{T_{dVdT}} \quad (7)$$

Power dissipation during start-up is:

$$P_{D(INRUSH)} = 0.5 \times V_{(IN)} \times I_{(INRUSH)} \quad (8)$$

Equation 8 assumes that load does not draw any current until the output voltage has reached its final value.

10.2.1.2.4.2 Case 2: Start-up with Load: Output Capacitance C_{OUT} and Load Draws Current During Start-up

When load draws current during the turn-on sequence, there will be additional power dissipated. Considering a resistive load during start-up ($R_{L(SU)}$), load current ramps up proportionally with increase in output voltage during T_{dVdT} time. The average power dissipation in the internal FET during charging time due to resistive load is given by:

$$P_{D(LOAD)} = \left(\frac{1}{6}\right) \times \frac{V_{(IN)}^2}{R_{L(SU)}} \quad (9)$$

Total power dissipated in the device during startup is:

$$P_{D(STARTUP)} = P_{D(INRUSH)} + P_{D(LOAD)} \quad (10)$$

Total current during startup is given by:

$$I_{(STARTUP)} = I_{(INRUSH)} + I_L(t) \quad (11)$$

If $I_{(STARTUP)} > I_{OL}$, the device limits the current to I_{OL} and the current limited charging time is determined by:

$$T_{dVdT(\text{Current-Limited})} = C_{OUT} \times R_{L(SU)} \times \left[\frac{I_{OL}}{I_{(INRUSH)}} - 1 + \text{LN} \left(\frac{I_{(INRUSH)}}{I_{OL} - \frac{V_{(IN)}}{R_{L(SU)}}} \right) \right] \quad (12)$$

The power dissipation, with and without load, for selected start-up time should not exceed the shutdown limits as shown in Figure 39.

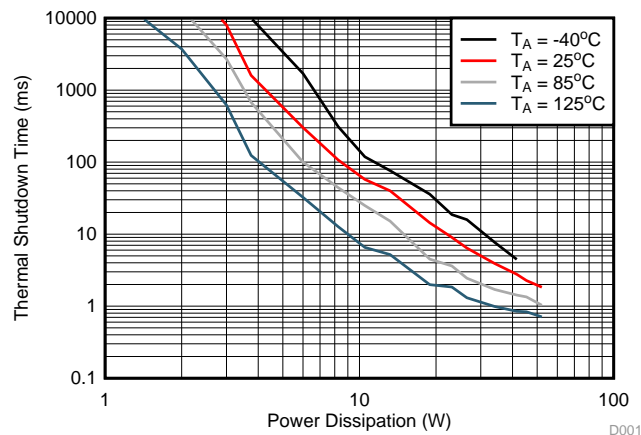

Figure 39. Thermal Shutdown Limit Plot

For the design example under discussion, select ramp-up capacitor $C_{dVdT} = \text{OPEN}$. Then, using Equation 2.

$$T_{dVdT} = 10^6 \times 5 \times (0 + 70 \text{ pF}) = 350 \text{ } \mu\text{s} \quad (13)$$

The inrush current drawn by the load capacitance (C_{OUT}) during ramp-up using Equation 7.

$$I_{(INRUSH)} = 1 \text{ } \mu\text{F} \times \frac{5}{350 \text{ } \mu\text{s}} = 14.3 \text{ mA} \quad (14)$$

The inrush Power dissipation is calculated, using Equation 8.

$$P_{D(INRUSH)} = 0.5 \times 5 \times 14.3 \text{ m} = 36 \text{ mW} \quad (15)$$

TPS2592BA, TPS2592BL

SLVSCU2 – DECEMBER 2014

www.ti.com

For 36 mW of power loss, the thermal shut down time of the device should not be less than the ramp-up time $T_{dV/dT}$ to avoid the false trip at maximum operating temperature. From thermal shutdown limit graph [Figure 39](#) at $T_A = 85^\circ\text{C}$, for 36 mW of power, the shutdown time is infinite. So it is safe to use 350 μs as start-up time without any load on output.

Considering the start-up with load 2 Ω , the additional power dissipation, when load is present during start up is calculated, using [Equation 9](#).

$$P_{D(\text{LOAD})} = \frac{5 \times 5}{6 \times 2} = 2.08 \text{ W} \tag{16}$$

The total device power dissipation during start up, using [Equation 10](#) is:

$$P_{D(\text{STARTUP})} = 2.08 + 36 \text{ m} = 2.44 \text{ W} \tag{17}$$

From thermal shutdown limit graph at $T_A = 85^\circ\text{C}$, the thermal shutdown time for 2.44 W is more than 100 ms. So it is well within acceptable limits to use no external capacitor ($C_{dV/dT}$) with start-up load of 2 Ω .

If, due to large C_{OUT} , there is a need to decrease the power loss during start-up, it can be done with increase of $C_{dV/dT}$ capacitor.

10.2.1.3 Support Component Selection - C_{VIN}

C_{VIN} is a bypass capacitor to help control transient voltages, unit emissions, and local supply noise. Where acceptable, a value in the range of 0.001 μF to 0.1 μF is recommended for C_{VIN} .

10.2.1.4 Application Curves

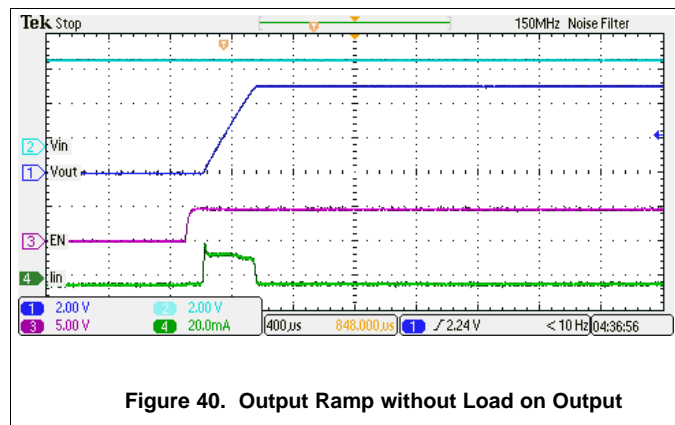

Figure 40. Output Ramp without Load on Output

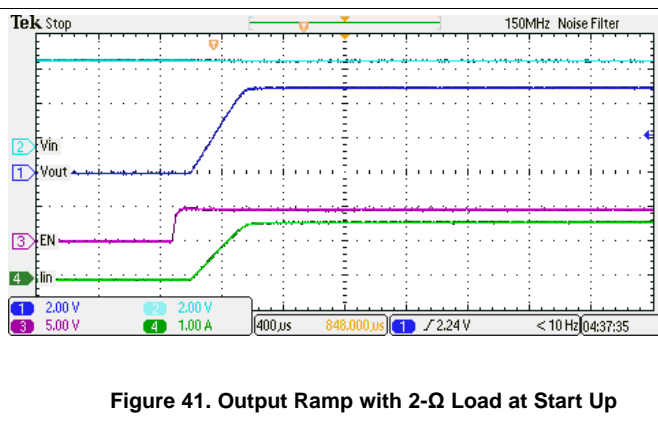
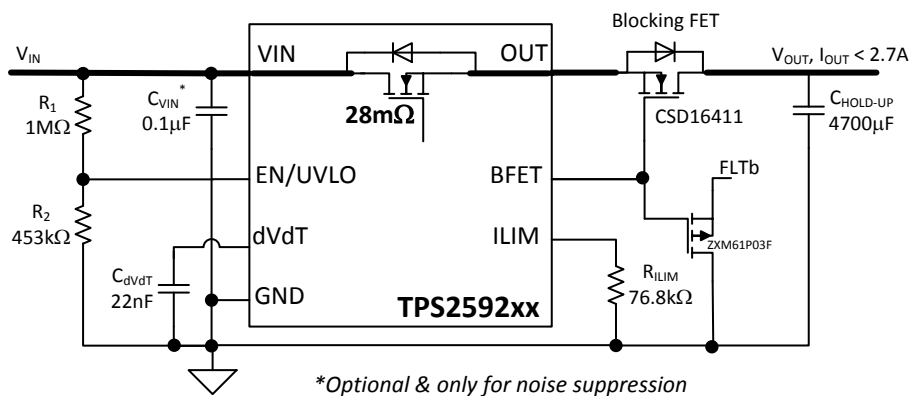

Figure 41. Output Ramp with 2- Ω Load at Start Up

10.2.2 Inrush and Reverse Current Protection for Hold-Up Capacitor Application (e.g., SSD)



*Optional & only for noise suppression

Figure 42. Inrush and Reverse Current Protection for Hold-Up Capacitor Application (e.g., SSD) (TPS2592 UVLO is used as power fail comparator)

10.2.2.1 Design Requirements

Table 3. Design Parameters

| DESIGN PARAMETER | EXAMPLE VALUE |
|--|----------------------------|
| Input voltage range, V_{IN} | 5 V |
| Undervoltage lockout set point, $V_{(UV)}$ | 4.5 V |
| Overshoot protection set point, $V_{(OV)}$ | Default: $V_{OVC} = 6.1$ V |
| Load at Start-Up, $R_{L(SU)}$ | 1000 Ω |
| Current limit, $I_{OL} = I_{LIM}$ | 3 A |
| Load capacitance, C_{OUT} | 4700 μ F |
| Maximum ambient temperatures, T_A | 85°C |

10.2.2.2 Detailed Design Procedure

10.2.2.2.1 Programming the Current-Limit Threshold: R_{ILIM} Selection

The R_{ILIM} resistor at the ILIM pin sets the over load current limit, this can be set using [Equation 4](#).

For $I_{OL} = I_{LIM} = 3$ A, from equation 4, $R_{ILIM} = 76.8$ k Ω , choose closest standard value resistor with 1% tolerance.

10.2.2.2.2 Undervoltage Lockout Set Point

The undervoltage lockout (UVLO) trip point is adjusted using the external voltage divider network of R_1 and R_2 as connected between IN, EN/UVLO and GND pins of the device. The values required for setting the undervoltage are calculated solving [Equation 5](#).

For UVLO of $V_{(UV)} = 4.5$ V, select $R_2 = 453$ k Ω , and $R_1 = 1$ M Ω .

The power failure threshold is detected on the falling edge of supply. This threshold voltage is 4% lower than the rising threshold, $V_{(UV)}$. This is calculated using [Equation 6](#).

Where $V_{(UV)} = 4.5$ V, Power fail threshold set is : $V_{(PFAIL)} = 4.33$ V

10.2.2.2.3 Setting Output Voltage Ramp Time (T_{dVdT})

For a successful design, the junction temperature of device should be kept below the absolute-maximum rating during both dynamic (start-up) and steady state conditions. Dynamic power stresses often are an order of magnitude greater than the static stresses, so it is important to determine the right start-up time and in-rush current limit required with system capacitance to avoid thermal shutdown during start-up with and without load.

For the design example under discussion, select ramp-up capacitor $C_{dVdT} = 22$ nF. Then, using [Equation 2](#).

$$T_{dVdT} = 10^6 \times 5 \times (22 \text{ nF} + 70 \text{ pF}) = 110 \text{ ms} \quad (18)$$

The inrush current drawn by the load capacitance (C_{OUT}) during ramp-up using [Equation 7](#).

$$I_{(INRUSH)} = 4700 \mu\text{F} \times \frac{5}{110 \text{ ms}} = 213 \text{ mA} \quad (19)$$

The inrush Power dissipation is calculated, using [Equation 8](#).

$$P_{D(INRUSH)} = 0.5 \times 5 \times 213 \text{ m} = 533 \text{ mW} \quad (20)$$

Considering the start-up with load 1000 Ω , the additional power dissipation, when load is present during start up is calculated, using [Equation 9](#).

$$P_{D(LOAD)} = \frac{5 \times 5}{6 \times 1000} = 4.2 \text{ mW} \quad (21)$$

The total device power dissipation during start up is:

$$P_{D(STARTUP)} = 533 + 4.2 = 537 \text{ mW} \quad (22)$$

From thermal shutdown limit graph at $T_A = 85^\circ\text{C}$, the thermal shutdown time for 537 mW is more than 300 ms. So the device will start safely.

TPS2592BA, TPS2592BL

SLVSCU2 – DECEMBER 2014

www.ti.com

10.2.2.3 Support Component Selection - C_{VIN}

C_{VIN} is a bypass capacitor to help control transient voltages, unit emissions, and local supply noise. Where acceptable, a value in the range of 0.001 μF to 0.1 μF is recommended for C_{VIN} .

10.2.2.4 Application Curves

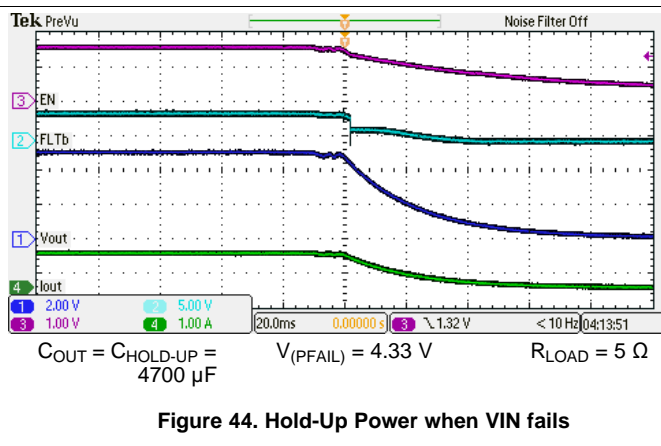
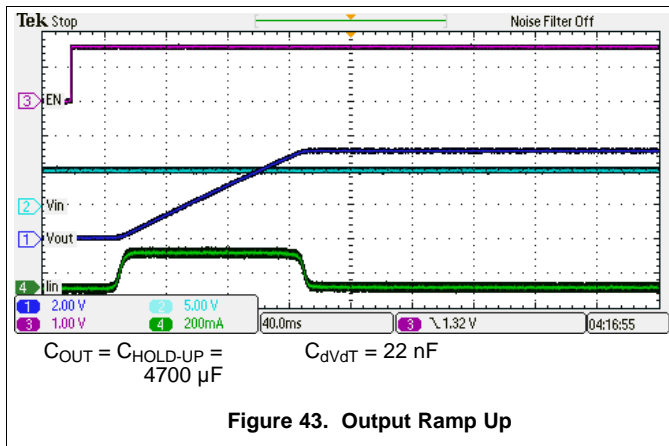

10.3 Maximum Device Power Dissipation Considerations

To prevent damage to the TPS2592x, it is necessary to keep internal power dissipation (P_D) below the levels specified in below Table. The power dissipation is defined as ($P_D = (V_{IN} - V_{OUT}) \times I_{OUT}$).

| | | MIN | MAX | UNIT |
|---------------------------|---|-----|-----|------|
| Maximum Power Dissipation | $-40^{\circ}\text{C} \leq T_A \leq +85^{\circ}\text{C}$ | | 40 | W |
| | $0^{\circ}\text{C} \leq T_A \leq +85^{\circ}\text{C}$ | | 50 | |

During normal operation P_D is low (typically $< \frac{1}{2}$ Watt) because the FET is fully on with low ($V_{IN} - V_{OUT}$). However, during short circuit and surge protection the FET may be only partially on and ($V_{IN} - V_{OUT}$) can be high.

Example 1: Short Circuit on Output → $V_{IN} = 5 \text{ V}$, $I_{LIMIT} = 5 \text{ A}$. $T_J = -40^{\circ}\text{C}$

- $P_D = 5 \text{ V} \times 5 \text{ A} = 25 \text{ W}$
- OK → ($P_D = 25 \text{ W}$) $<$ ($P_{D_MAX} = 40 \text{ W}$)

Example 2: Surge Clamp → $V_{IN} = 5 \text{ V}$, $I_{LIMIT} = 3.7 \text{ A}$. $T_J = 0^{\circ}\text{C}$, $V_{SURGE} = 19 \text{ V}$, $V_{CLAMP} = 6.1 \text{ V}$

- $P_D = (19 - 6.1) \times 3 \text{ A} = 47.7 \text{ Watt}$
- OK at $T_J = 0^{\circ}\text{C}$ → ($P_D = 47.7 \text{ W}$) $<$ (P_{D_MAX} at $0^{\circ}\text{C} = 50 \text{ W}$)
- NOT OK at -40°C → ($P_D = 47.7 \text{ W}$) $>$ (P_{D_MAX} at $-40^{\circ}\text{C} = 40 \text{ W}$)

11 Power Supply Recommendations

The device is designed for supply voltage range of $4.5\text{ V} \leq V_{IN} \leq 18\text{ V}$. If the input supply is located more than a few inches from the device an input ceramic bypass capacitor higher than $0.1\ \mu\text{F}$ is recommended. Power supply should be rated higher than the current limit set to avoid voltage droops during over current and short-circuit conditions.

11.1 Transient Protection

In case of short circuit and over load current limit, when the device interrupts current flow, input inductance generates a positive voltage spike on the input and output inductance generates a negative voltage spike on the output. The peak amplitude of voltage spikes (transients) is dependent on value of inductance in series to the input or output of the device. Such transients can exceed the *Absolute Maximum Ratings* of the device if steps are not taken to address the issue.

Typical methods for addressing transients include

- Minimizing lead length and inductance into and out of the device
- Using large PCB GND plane
- Schottky diode across the output to absorb negative spikes
- A low value ceramic capacitor ($C_{(IN)} = 0.001\ \mu\text{F}$ to $0.1\ \mu\text{F}$) to absorb the energy and dampen the transients. The approximate value of input capacitance can be estimated with [Equation 23](#).

$$V_{\text{SPIKE(Absolute)}} = V_{(IN)} + I_{(LOAD)} \times \sqrt{\frac{L_{(IN)}}{C_{(IN)}}} \quad (23)$$

Where:

- $V_{(IN)}$ is the nominal supply voltage
- $I_{(LOAD)}$ is the load current,
- $L_{(IN)}$ equals the effective inductance seen looking into the source
- $C_{(IN)}$ is the capacitance present at the input

Some applications may require the addition of a Transient Voltage Suppressor (TVS) to prevent transients from exceeding the *Absolute Maximum Ratings* of the device.

The circuit implementation with optional protection components (a ceramic capacitor, TVS and schottky diode) is shown in [Figure 45](#).

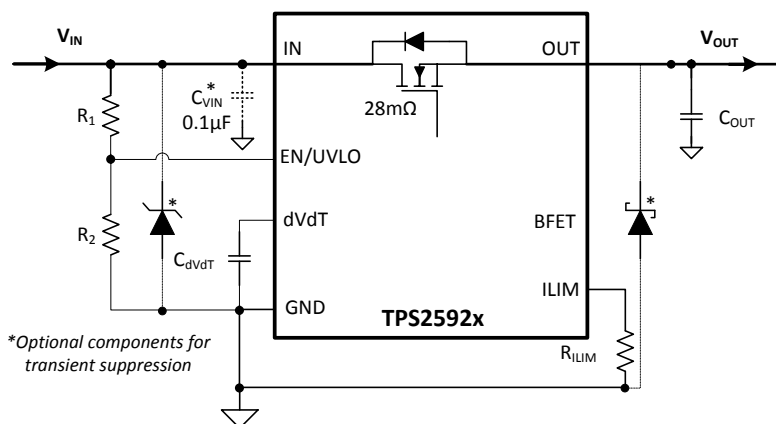

Figure 45. Circuit Implementation with Optional Protection Components

11.2 Output Short-Circuit Measurements

It is difficult to obtain repeatable and similar short-circuit testing results. Source bypassing, input leads, circuit layout and component selection, output shorting method, relative location of the short, and instrumentation all contribute to variation in results. The actual short itself exhibits a certain degree of randomness as it microscopically bounces and arcs. Care in configuration and methods must be used to obtain realistic results. Do not expect to see waveforms exactly like those in the data sheet; every setup differs.

12 Layout

12.1 Layout Guidelines

- For all applications, a 0.01-uF or greater ceramic decoupling capacitor is recommended between IN terminal and GND. For hot-plug applications, where input power path inductance is negligible, this capacitor can be eliminated/minimized.
- The optimum placement of decoupling capacitor is closest to the IN and GND terminals of the device. Care must be taken to minimize the loop area formed by the bypass-capacitor connection, the IN terminal, and the GND terminal of the IC. See Figure 46 for a PCB layout example.
- High current carrying power path connections should be as short as possible and should be sized to carry at least twice the full-load current.
- The GND terminal must be tied to the PCB ground plane at the terminal of the IC. The PCB ground should be a copper plane or island on the board.
- Locate all support components: R_{ILIM} , C_{dVdT} and resistors for EN/UVLO, close to their connection pin. Connect the other end of the component to the GND pin of the device with shortest trace length. The trace routing for the R_{ILIM} and C_{dVdT} components to the device should be as short as possible to reduce parasitic effects on the current limit and soft start timing. These traces should not have any coupling to switching signals on the board.
- Protection devices such as TVS, snubbers, capacitors, or diodes should be placed physically close to the device they are intended to protect, and routed with short traces to reduce inductance. For example, a protection Schottky diode is recommended to address negative transients due to switching of inductive loads, and it should be physically close to the OUT pins.
- Obtaining acceptable performance with alternate layout schemes is possible; however this layout has been shown to produce good results and is intended as a guideline.

12.2 Layout Example

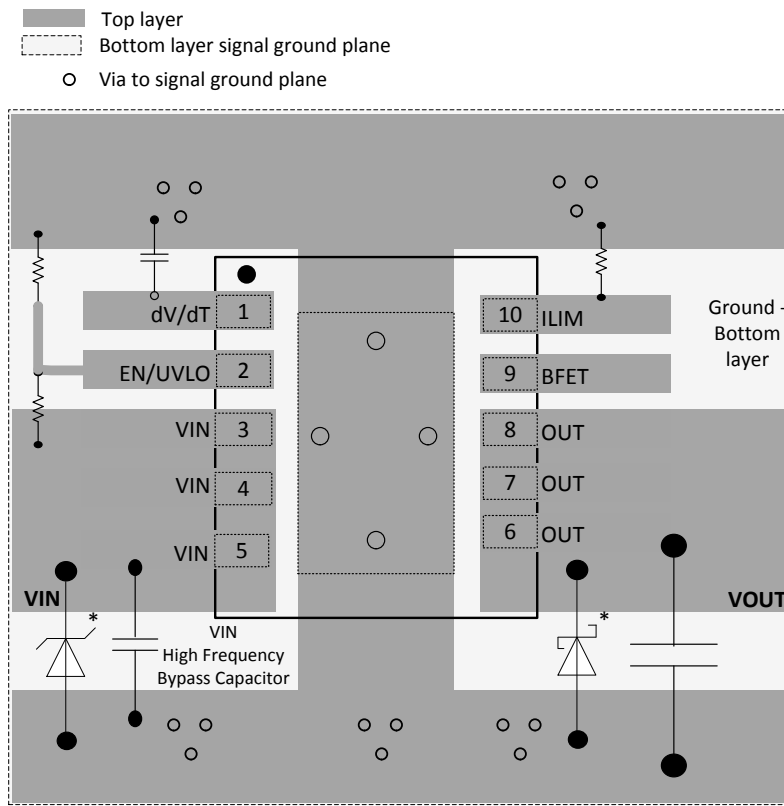

Figure 46. Layout Example

13 Device and Documentation Support

13.1 Device Support

13.1.1 Third-Party Products Disclaimer

TI'S PUBLICATION OF INFORMATION REGARDING THIRD-PARTY PRODUCTS OR SERVICES DOES NOT CONSTITUTE AN ENDORSEMENT REGARDING THE SUITABILITY OF SUCH PRODUCTS OR SERVICES OR A WARRANTY, REPRESENTATION OR ENDORSEMENT OF SUCH PRODUCTS OR SERVICES, EITHER ALONE OR IN COMBINATION WITH ANY TI PRODUCT OR SERVICE.

13.2 Related Links

The table below lists quick access links. Categories include technical documents, support and community resources, tools and software, and quick access to sample or buy.

Table 4. Related Links

| PARTS | PRODUCT FOLDER | SAMPLE & BUY | TECHNICAL DOCUMENTS | TOOLS & SOFTWARE | SUPPORT & COMMUNITY |
|-----------|----------------------------|----------------------------|----------------------------|----------------------------|----------------------------|
| TPS2592BA | Click here | Click here | Click here | Click here | Click here |
| TPS2592BL | Click here | Click here | Click here | Click here | Click here |

13.3 Trademarks

PowerPAD is a trademark of Texas Instruments.

WEBENCH is a registered trademark of Texas Instruments.

All other trademarks are the property of their respective owners.

13.4 Electrostatic Discharge Caution



These devices have limited built-in ESD protection. The leads should be shorted together or the device placed in conductive foam during storage or handling to prevent electrostatic damage to the MOS gates.

13.5 Glossary

[SLYZ022](#) — *TI Glossary*.

This glossary lists and explains terms, acronyms, and definitions.

14 Mechanical, Packaging, and Orderable Information

The following pages include mechanical, packaging, and orderable information. This information is the most current data available for the designated devices. This data is subject to change without notice and revision of this document. For browser-based versions of this data sheet, refer to the left-hand navigation.

PACKAGING INFORMATION

| Orderable Device | Status (1) | Package Type | Package Drawing | Pins | Package Qty | Eco Plan (2) | Lead/Ball Finish (6) | MSL Peak Temp (3) | Op Temp (°C) | Device Marking (4/5) | Samples |
|------------------|---------------|--------------|-----------------|------|-------------|-------------------------|-------------------------|----------------------|--------------|-------------------------|---------|
| TPS2592BADRCR | NRND | VSON | DRC | 10 | 3000 | Green (RoHS & no Sb/Br) | CU NIPDAU | Level-2-260C-1 YEAR | -40 to 125 | 2592BA | |
| TPS2592BADRCT | NRND | VSON | DRC | 10 | 250 | Green (RoHS & no Sb/Br) | CU NIPDAU | Level-2-260C-1 YEAR | -40 to 125 | 2592BA | |
| TPS2592BLDRCR | NRND | VSON | DRC | 10 | 3000 | Green (RoHS & no Sb/Br) | CU NIPDAU | Level-2-260C-1 YEAR | -40 to 125 | 2592BL | |
| TPS2592BLDRCT | NRND | VSON | DRC | 10 | 250 | Green (RoHS & no Sb/Br) | CU NIPDAU | Level-2-260C-1 YEAR | -40 to 125 | 2592BL | |

(1) The marketing status values are defined as follows:

ACTIVE: Product device recommended for new designs.

LIFEBUY: TI has announced that the device will be discontinued, and a lifetime-buy period is in effect.

NRND: Not recommended for new designs. Device is in production to support existing customers, but TI does not recommend using this part in a new design.

PREVIEW: Device has been announced but is not in production. Samples may or may not be available.

OBSELETE: TI has discontinued the production of the device.

(2) Eco Plan - The planned eco-friendly classification: Pb-Free (RoHS), Pb-Free (RoHS Exempt), or Green (RoHS & no Sb/Br) - please check <http://www.ti.com/productcontent> for the latest availability information and additional product content details.

TBD: The Pb-Free/Green conversion plan has not been defined.

Pb-Free (RoHS): TI's terms "Lead-Free" or "Pb-Free" mean semiconductor products that are compatible with the current RoHS requirements for all 6 substances, including the requirement that lead not exceed 0.1% by weight in homogeneous materials. Where designed to be soldered at high temperatures, TI Pb-Free products are suitable for use in specified lead-free processes.

Pb-Free (RoHS Exempt): This component has a RoHS exemption for either 1) lead-based flip-chip solder bumps used between the die and package, or 2) lead-based die adhesive used between the die and leadframe. The component is otherwise considered Pb-Free (RoHS compatible) as defined above.

Green (RoHS & no Sb/Br): TI defines "Green" to mean Pb-Free (RoHS compatible), and free of Bromine (Br) and Antimony (Sb) based flame retardants (Br or Sb do not exceed 0.1% by weight in homogeneous material)

(3) MSL, Peak Temp. - The Moisture Sensitivity Level rating according to the JEDEC industry standard classifications, and peak solder temperature.

(4) There may be additional marking, which relates to the logo, the lot trace code information, or the environmental category on the device.

(5) Multiple Device Markings will be inside parentheses. Only one Device Marking contained in parentheses and separated by a "~" will appear on a device. If a line is indented then it is a continuation of the previous line and the two combined represent the entire Device Marking for that device.

(6) Lead/Ball Finish - Orderable Devices may have multiple material finish options. Finish options are separated by a vertical ruled line. Lead/Ball Finish values may wrap to two lines if the finish value exceeds the maximum column width.

Important Information and Disclaimer: The information provided on this page represents TI's knowledge and belief as of the date that it is provided. TI bases its knowledge and belief on information provided by third parties, and makes no representation or warranty as to the accuracy of such information. Efforts are underway to better integrate information from third parties. TI has taken and continues to take reasonable steps to provide representative and accurate information but may not have conducted destructive testing or chemical analysis on incoming materials and chemicals. TI and TI suppliers consider certain information to be proprietary, and thus CAS numbers and other limited information may not be available for release.

In no event shall TI's liability arising out of such information exceed the total purchase price of the TI part(s) at issue in this document sold by TI to Customer on an annual basis.

TAPE AND REEL INFORMATION

QUADRANT ASSIGNMENTS FOR PIN 1 ORIENTATION IN TAPE

*All dimensions are nominal

| Device | Package Type | Package Drawing | Pins | SPQ | Reel Diameter (mm) | Reel Width W1 (mm) | A0 (mm) | B0 (mm) | K0 (mm) | P1 (mm) | W (mm) | Pin1 Quadrant |
|---------------|--------------|-----------------|------|------|--------------------|--------------------|---------|---------|---------|---------|--------|---------------|
| TPS2592BADRCR | VSON | DRC | 10 | 3000 | 330.0 | 12.4 | 3.3 | 3.3 | 1.1 | 8.0 | 12.0 | Q2 |
| TPS2592BADRCT | VSON | DRC | 10 | 250 | 180.0 | 12.4 | 3.3 | 3.3 | 1.1 | 8.0 | 12.0 | Q2 |
| TPS2592BLDRCR | VSON | DRC | 10 | 3000 | 330.0 | 12.4 | 3.3 | 3.3 | 1.1 | 8.0 | 12.0 | Q2 |
| TPS2592BLDRCT | VSON | DRC | 10 | 250 | 180.0 | 12.4 | 3.3 | 3.3 | 1.1 | 8.0 | 12.0 | Q2 |

TAPE AND REEL BOX DIMENSIONS

*All dimensions are nominal

| Device | Package Type | Package Drawing | Pins | SPQ | Length (mm) | Width (mm) | Height (mm) |
|---------------|--------------|-----------------|------|------|-------------|------------|-------------|
| TPS2592BADRCR | VSON | DRC | 10 | 3000 | 367.0 | 367.0 | 35.0 |
| TPS2592BADRCT | VSON | DRC | 10 | 250 | 210.0 | 185.0 | 35.0 |
| TPS2592BLDRCR | VSON | DRC | 10 | 3000 | 367.0 | 367.0 | 35.0 |
| TPS2592BLDRCT | VSON | DRC | 10 | 250 | 210.0 | 185.0 | 35.0 |

DRC (S-PVSON-N10)

PLASTIC SMALL OUTLINE NO-LEAD

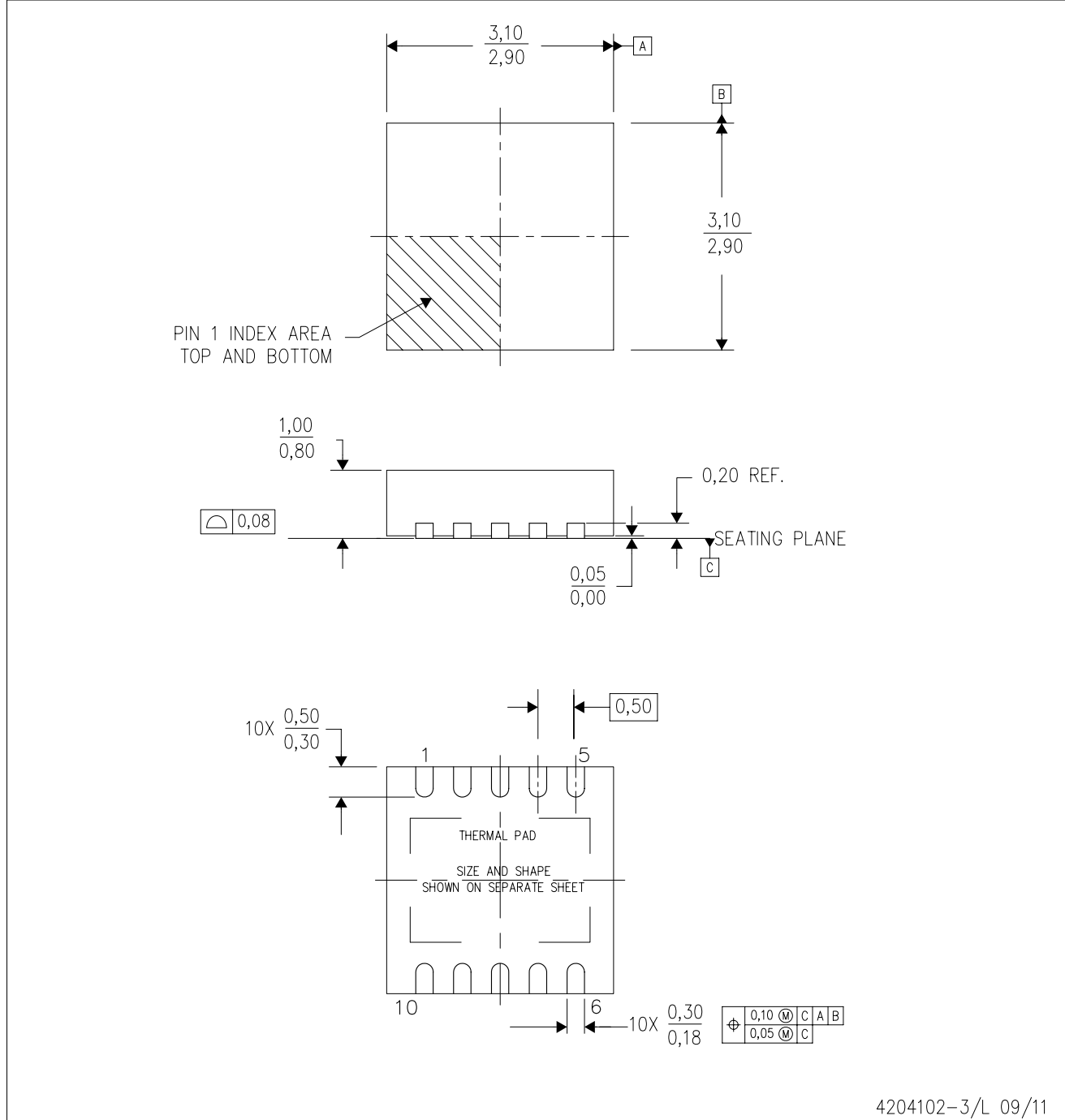

4204102-3/L 09/11

- NOTES:
- All linear dimensions are in millimeters. Dimensioning and tolerancing per ASME Y14.5M-1994.
 - This drawing is subject to change without notice.
 - Small Outline No-Lead (SON) package configuration.
 - The package thermal pad must be soldered to the board for thermal and mechanical performance, if present.
 - See the additional figure in the Product Data Sheet for details regarding the exposed thermal pad features and dimensions, if present

THERMAL PAD MECHANICAL DATA

DRC (S-PVSON-N10)

PLASTIC SMALL OUTLINE NO-LEAD

THERMAL INFORMATION

This package incorporates an exposed thermal pad that is designed to be attached directly to an external heatsink. The thermal pad must be soldered directly to the printed circuit board (PCB). After soldering, the PCB can be used as a heatsink. In addition, through the use of thermal vias, the thermal pad can be attached directly to the appropriate copper plane shown in the electrical schematic for the device, or alternatively, can be attached to a special heatsink structure designed into the PCB. This design optimizes the heat transfer from the integrated circuit (IC).

For information on the Quad Flatpack No-Lead (QFN) package and its advantages, refer to Application Report, QFN/SON PCB Attachment, Texas Instruments Literature No. SLUA271. This document is available at www.ti.com.

The exposed thermal pad dimensions for this package are shown in the following illustration.

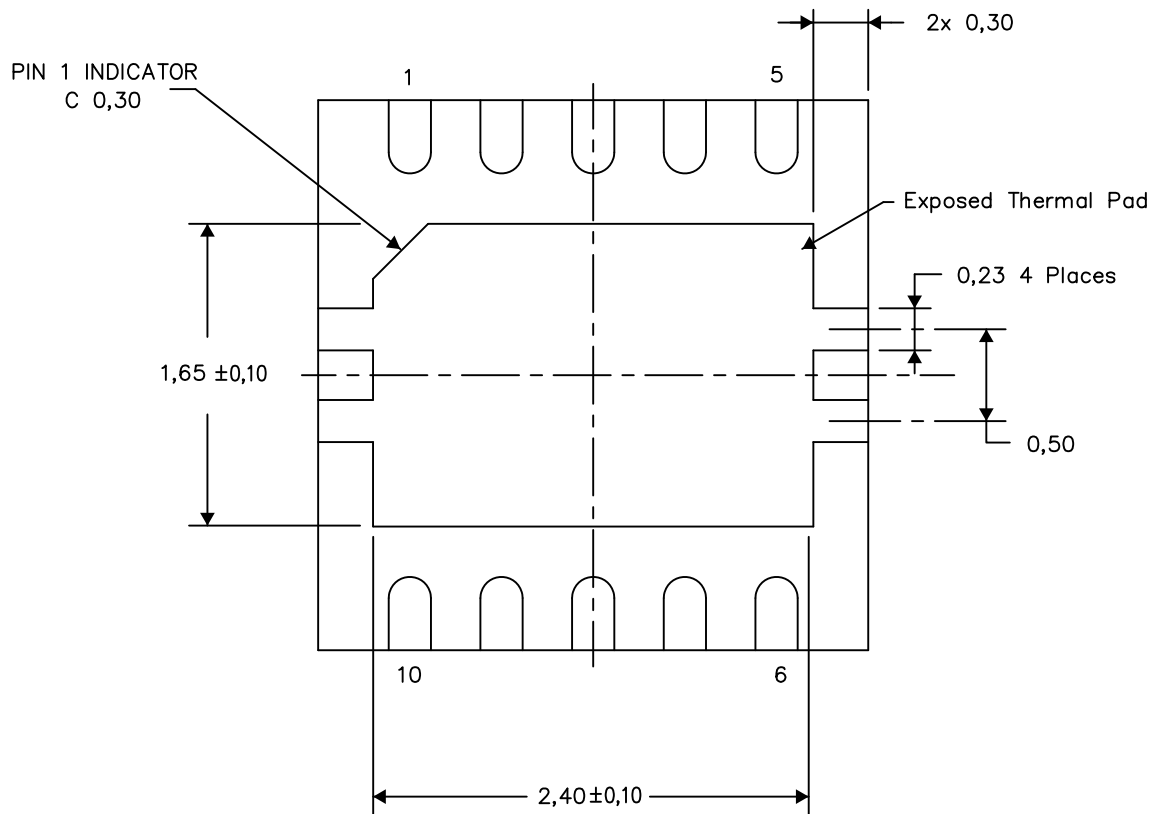

Bottom View

Exposed Thermal Pad Dimensions

4206565-3/Y 08/15

NOTE: A. All linear dimensions are in millimeters

LAND PATTERN DATA

DRC (S-PVSON-N10)

PLASTIC SMALL OUTLINE NO-LEAD

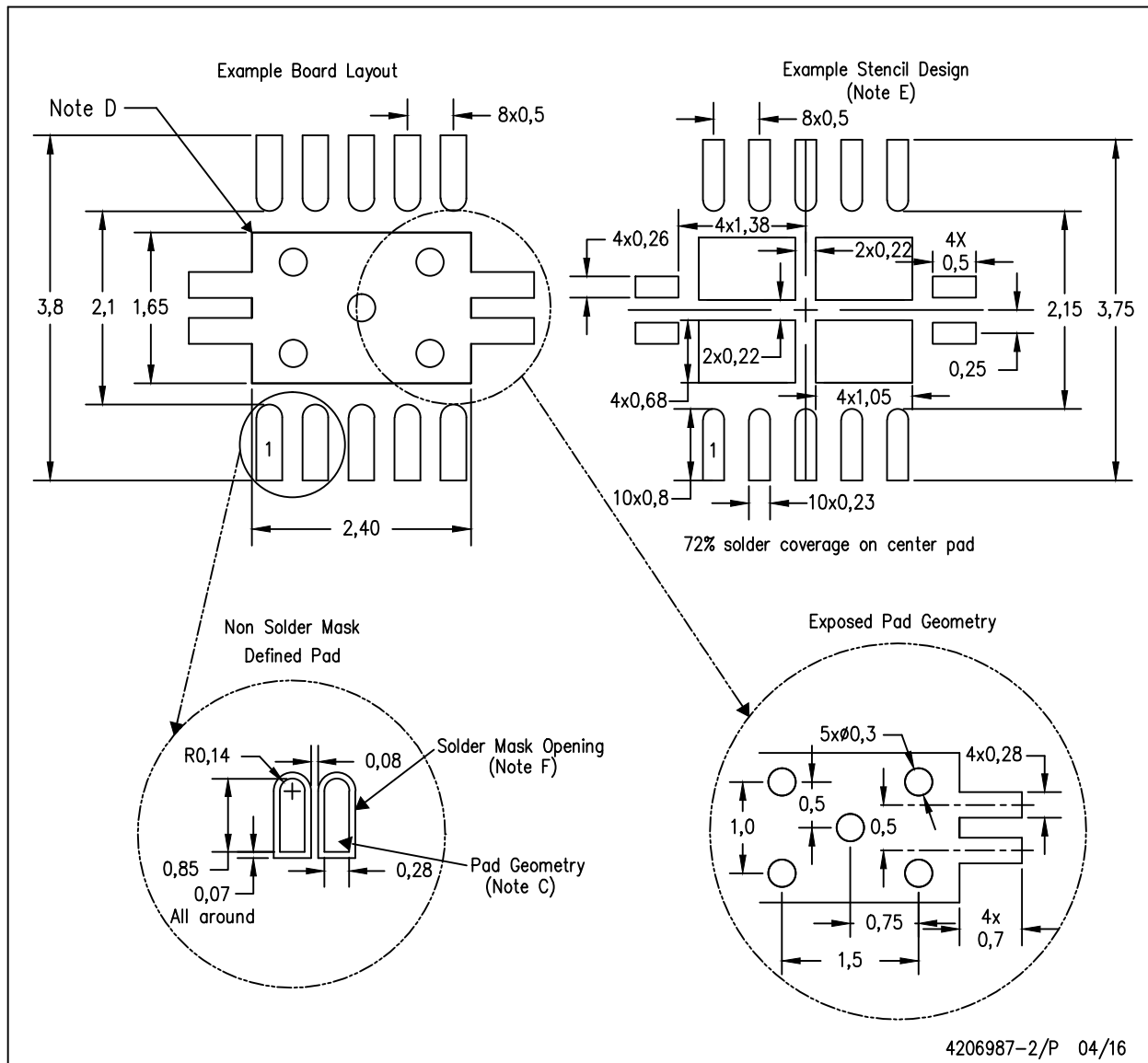

- NOTES:
- All linear dimensions are in millimeters.
 - This drawing is subject to change without notice.
 - Publication IPC-7351 is recommended for alternate designs.
 - This package is designed to be soldered to a thermal pad on the board. Refer to Application Note, Quad Flat-Pack Packages, Texas Instruments Literature No. SLUA271, and also the Product Data Sheets for specific thermal information, via requirements, and recommended board layout. These documents are available at www.ti.com <<http://www.ti.com>>.
 - Laser cutting apertures with trapezoidal walls and also rounding corners will offer better paste release. Customers should contact their board assembly site for stencil design recommendations. Refer to IPC 7525 for stencil design considerations.
 - Customers should contact their board fabrication site for minimum solder mask web tolerances between signal pads.

IMPORTANT NOTICE

Texas Instruments Incorporated and its subsidiaries (TI) reserve the right to make corrections, enhancements, improvements and other changes to its semiconductor products and services per JESD46, latest issue, and to discontinue any product or service per JESD48, latest issue. Buyers should obtain the latest relevant information before placing orders and should verify that such information is current and complete. All semiconductor products (also referred to herein as "components") are sold subject to TI's terms and conditions of sale supplied at the time of order acknowledgment.

TI warrants performance of its components to the specifications applicable at the time of sale, in accordance with the warranty in TI's terms and conditions of sale of semiconductor products. Testing and other quality control techniques are used to the extent TI deems necessary to support this warranty. Except where mandated by applicable law, testing of all parameters of each component is not necessarily performed.

TI assumes no liability for applications assistance or the design of Buyers' products. Buyers are responsible for their products and applications using TI components. To minimize the risks associated with Buyers' products and applications, Buyers should provide adequate design and operating safeguards.

TI does not warrant or represent that any license, either express or implied, is granted under any patent right, copyright, mask work right, or other intellectual property right relating to any combination, machine, or process in which TI components or services are used. Information published by TI regarding third-party products or services does not constitute a license to use such products or services or a warranty or endorsement thereof. Use of such information may require a license from a third party under the patents or other intellectual property of the third party, or a license from TI under the patents or other intellectual property of TI.

Reproduction of significant portions of TI information in TI data books or data sheets is permissible only if reproduction is without alteration and is accompanied by all associated warranties, conditions, limitations, and notices. TI is not responsible or liable for such altered documentation. Information of third parties may be subject to additional restrictions.

Resale of TI components or services with statements different from or beyond the parameters stated by TI for that component or service voids all express and any implied warranties for the associated TI component or service and is an unfair and deceptive business practice. TI is not responsible or liable for any such statements.

Buyer acknowledges and agrees that it is solely responsible for compliance with all legal, regulatory and safety-related requirements concerning its products, and any use of TI components in its applications, notwithstanding any applications-related information or support that may be provided by TI. Buyer represents and agrees that it has all the necessary expertise to create and implement safeguards which anticipate dangerous consequences of failures, monitor failures and their consequences, lessen the likelihood of failures that might cause harm and take appropriate remedial actions. Buyer will fully indemnify TI and its representatives against any damages arising out of the use of any TI components in safety-critical applications.

In some cases, TI components may be promoted specifically to facilitate safety-related applications. With such components, TI's goal is to help enable customers to design and create their own end-product solutions that meet applicable functional safety standards and requirements. Nonetheless, such components are subject to these terms.

No TI components are authorized for use in FDA Class III (or similar life-critical medical equipment) unless authorized officers of the parties have executed a special agreement specifically governing such use.

Only those TI components which TI has specifically designated as military grade or "enhanced plastic" are designed and intended for use in military/aerospace applications or environments. Buyer acknowledges and agrees that any military or aerospace use of TI components which have **not** been so designated is solely at the Buyer's risk, and that Buyer is solely responsible for compliance with all legal and regulatory requirements in connection with such use.

TI has specifically designated certain components as meeting ISO/TS16949 requirements, mainly for automotive use. In any case of use of non-designated products, TI will not be responsible for any failure to meet ISO/TS16949.

Products

| | |
|------------------------------|--|
| Audio | www.ti.com/audio |
| Amplifiers | amplifier.ti.com |
| Data Converters | dataconverter.ti.com |
| DLP® Products | www.dlp.com |
| DSP | dsp.ti.com |
| Clocks and Timers | www.ti.com/clocks |
| Interface | interface.ti.com |
| Logic | logic.ti.com |
| Power Mgmt | power.ti.com |
| Microcontrollers | microcontroller.ti.com |
| RFID | www.ti-rfid.com |
| OMAP Applications Processors | www.ti.com/omap |
| Wireless Connectivity | www.ti.com/wirelessconnectivity |

Applications

| | |
|-------------------------------|--|
| Automotive and Transportation | www.ti.com/automotive |
| Communications and Telecom | www.ti.com/communications |
| Computers and Peripherals | www.ti.com/computers |
| Consumer Electronics | www.ti.com/consumer-apps |
| Energy and Lighting | www.ti.com/energy |
| Industrial | www.ti.com/industrial |
| Medical | www.ti.com/medical |
| Security | www.ti.com/security |
| Space, Avionics and Defense | www.ti.com/space-avionics-defense |
| Video and Imaging | www.ti.com/video |

TI E2E Community

e2e.ti.com