

TPS7201Q, TPS7225Q, TPS7230Q
 TPS7233Q, TPS7248Q, TPS7250Q, TPS72xxY
MICROPOWER LOW-DROPOUT (LDO) VOLTAGE REGULATORS

SLVS102G – MARCH 1995 – REVISED JUNE 2000

- Available in 5-V, 4.85-V, 3.3-V, 3.0-V, and 2.5-V Fixed-Output and Adjustable Versions
- Dropout Voltage <85 mV Max at $I_O = 100$ mA (TPS7250)
- Low Quiescent Current, Independent of Load, 180 μ A Typ
- 8-Pin SOIC and 8-Pin TSSOP Package
- Output Regulated to $\pm 2\%$ Over Full Operating Range for Fixed-Output Versions
- Extremely Low Sleep-State Current, 0.5 μ A Max
- Power-Good (PG) Status Output

description

The TPS72xx family of low-dropout (LDO) voltage regulators offers the benefits of low-dropout voltage, micropower operation, and miniaturized packaging. These regulators feature extremely low dropout voltages and quiescent currents compared to conventional LDO regulators. Offered in small-outline integrated-circuit (SOIC) packages and 8-terminal thin shrink small-outline (TSSOP), the TPS72xx series devices are ideal for cost-sensitive designs and for designs where board space is at a premium.

A combination of new circuit design and process innovation has enabled the usual pnp pass transistor to be replaced by a PMOS device. Because the PMOS pass element behaves as a low-value resistor, the dropout voltage is very low – maximum of 85 mV at 100 mA of load current (TPS7250) – and is directly proportional to the load current (see Figure 1). Since the PMOS pass element is a voltage-driven device, the quiescent current is very low (300 μ A maximum) and is stable over the entire range of output load current (0 mA to 250 mA). Intended for use in portable systems such as laptops and cellular phones, the low-dropout voltage and micropower operation result in a significant increase in system battery operating life.

The TPS72xx also features a logic-enabled sleep mode to shut down the regulator, reducing quiescent current to 0.5 μ A maximum at $T_J = 25^\circ\text{C}$. Other features include a power-good function that reports low output voltage and may be used to implement a power-on reset or a low-battery indicator.

The TPS72xx is offered in 2.5-V, 3-V, 3.3-V, 4.85-V, and 5-V fixed-voltage versions and in an adjustable version (programmable over the range of 1.2 V to 9.75 V). Output voltage tolerance is specified as a maximum of 2% over line, load, and temperature ranges (3% for adjustable version).

**D, P, OR PW PACKAGE
(TOP VIEW)**

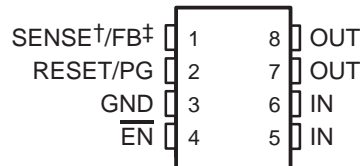

† SENSE – Fixed voltage options only (TPS7225, TPS7230, TPS7233, TPS7248, and TPS7250)

‡ FB – Adjustable version only (TPS7201)

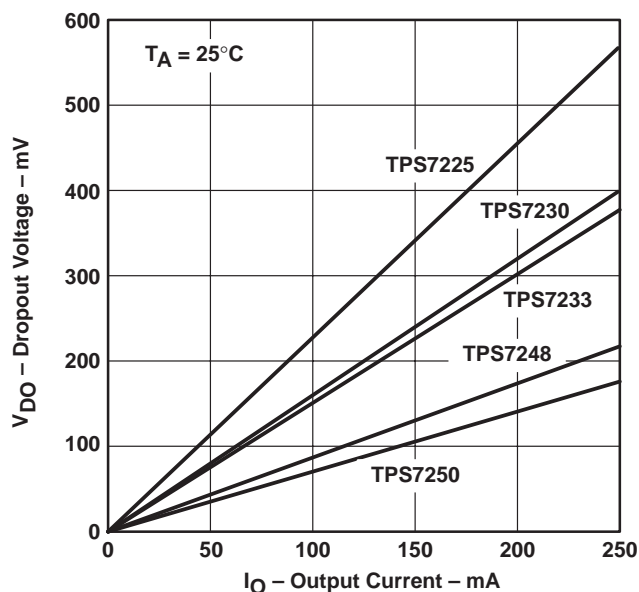

Figure 1. Typical Dropout Voltage Versus Output Current



Please be aware that an important notice concerning availability, standard warranty, and use in critical applications of Texas Instruments semiconductor products and disclaimers thereto appears at the end of this data sheet.

PRODUCTION DATA information is current as of publication date. Products conform to specifications per the terms of Texas Instruments standard warranty. Production processing does not necessarily include testing of all parameters.



POST OFFICE BOX 655303 • DALLAS, TEXAS 75265

Copyright © 2000, Texas Instruments Incorporated

TPS7201Q, TPS7225Q, TPS7230Q
 TPS7233Q, TPS7248Q, TPS7250Q, TPS72xxY
 MICROPOWER LOW-DROPOUT (LDO) VOLTAGE REGULATORS

SLVS102G – MARCH 1995 – REVISED JUNE 2000

AVAILABLE OPTIONS

T _J	OUTPUT VOLTAGE (V)			PACKAGED DEVICES			CHIP FORM (Y)
	MIN	TYP	MAX	SMALL OUTLINE (D)	PDIP (P)	TSSOP (PW)	
-55°C to 150°C	4.9	5	5.1	TPS7250QD	TPS7250QP	TPS7250QPWR	TPS7250Y
	4.75	4.85	4.95	TPS7248QD	TPS7248QP	TPS7248QPWR	TPS7248Y
	3.23	3.3	3.37	TPS7233QD	TPS7233QP	TPS7233QPWR	TPS7233Y
	2.94	3	3.06	TPS7230QD	TPS7230QP	TPS7230QPWR	TPS7230Y
	2.45	2.5	2.55	TPS7225QD	TPS7225QP	TPS7225QPWR	TPS7225Y
	Adjustable 1.2 V to 9.75 V			TPS7201QD	TPS7201QP	TPS7201QPWR	TPS7201Y

The D package is available taped and reeled. Add R suffix to device type (e.g., TPS7250QDR). The PW package is only available left-end taped and reeled. The TPS7201Q is programmable using an external resistor divider (see application information). The chip form is tested at 25°C.

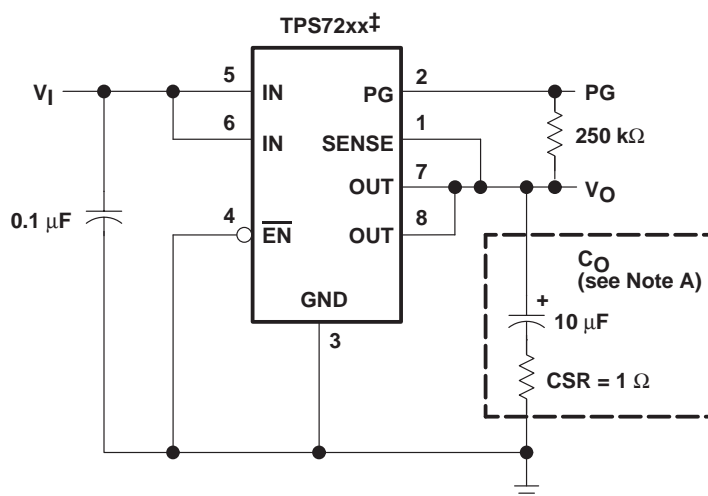

‡ TPS7225Q, TPS7230Q, TPS7233Q, TPS7248Q, TPS7250Q (fixed-voltage options)

NOTE A: Capacitor selection is nontrivial. See application information section for details.

Figure 2. Typical Application Configuration

**TPS7201Q, TPS7225Q, TPS7230Q
TPS7233Q, TPS7248Q, TPS7250Q, TPS72xxY
MICROPOWER LOW-DROPOUT (LDO) VOLTAGE REGULATORS**

SLVS102G – MARCH 1995 – REVISED JUNE 2000

TPS72xx chip information

These chips, when properly assembled, display characteristics similar to the TPS72xxQ. Thermal compression or ultrasonic bonding may be used on the doped aluminum bonding pads. The chips may be mounted with conductive epoxy or a gold-silicon preform.

BONDING PAD ASSIGNMENTS

TPS72xx

(1) GND

IN (3) EN (2)

(5) SENSE† (6) FB‡

(4) OUT (7) PG

CHIP THICKNESS: 15 MILS TYPICAL

BONDING PADS: 4 × 4 MILS MINIMUM

T_{jmax} = 150°C

TOLERANCES ARE ±10%.

ALL DIMENSIONS ARE IN MILS.

† Fixed-voltage options only (TPS7225, TPS7230, TPS7233, TPS7248, and TPS7250)

‡ Adjustable version only (TPS7201)

NOTE A. For most applications, OUT and SENSE should be tied together as close as possible to the device; for other implementations, refer to the SENSE-pin connection discussion in the application information section of this data sheet.

functional block diagram

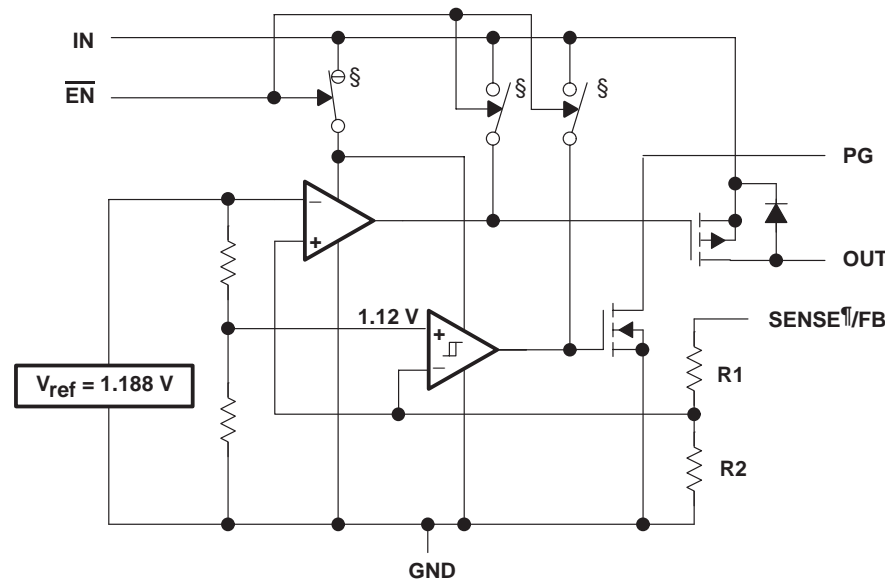

RESISTOR DIVIDER OPTIONS

DEVICE	R1	R2	UNIT
TPS7201	0	∞	Ω
TPS7225	257	233	kΩ
TPS7230	357	233	kΩ
TPS7233	420	233	kΩ
TPS7248	726	233	kΩ
TPS7250	756	233	kΩ

NOTE A: Resistors are nominal values only.

COMPONENT COUNT

MOS transistors	108
Bipolar transistors	41
Diodes	4
Capacitors	15
Resistors	75

§ Switch positions are shown with EN low (active).

¶ For most applications, SENSE should be externally connected to OUT as close as possible to the device. For other implementations, refer to the SENSE-pin connection discussion in application information section.

TPS7201Q, TPS7225Q, TPS7230Q
 TPS7233Q, TPS7248Q, TPS7250Q, TPS72xxY
MICROPOWER LOW-DROPOUT (LDO) VOLTAGE REGULATORS

SLVS102G – MARCH 1995 – REVISED JUNE 2000

absolute maximum ratings over operating free-air temperature range (unless otherwise noted)†

Input voltage range‡, V_I , PG, SENSE, \overline{EN}	-0.3 V to 11 V
Output current, I_O	1.5 A
Continuous total power dissipation	See Dissipation Rating Tables 1 and 2
Operating virtual junction temperature range, T_J	-55°C to 150°C
Storage temperature range, T_{stg}	-65°C to 150°C
Lead temperature 1,6 mm (1/16 inch) from case for 10 seconds	260°C

† Stresses beyond those listed under “absolute maximum ratings” may cause permanent damage to the device. These are stress ratings only, and functional operation of the device at these or any other conditions beyond those indicated under “recommended operating conditions” is not implied. Exposure to absolute-maximum-rated conditions for extended periods may affect device reliability.

‡ All voltage values are with respect to network ground terminal.

DISSIPATION RATING TABLE 1 – FREE-AIR TEMPERATURE (see Note 1 and Figure 3)

PACKAGE	$T_A \leq 25^\circ\text{C}$ POWER RATING	DERATING FACTOR ABOVE $T_A = 25^\circ\text{C}$	$T_A = 70^\circ\text{C}$ POWER RATING	$T_A = 85^\circ\text{C}$ POWER RATING	$T_A = 125^\circ\text{C}$ POWER RATING
D	725 mW	5.8 mW/°C	464 mW	377 mW	145 mW
P	1175 mW	8.74 mW/°C	782 mW	650 mW	301 mW
PW	525 mW	4.2 mW/°C	336 mW	273 mW	105 mW

DISSIPATION RATING TABLE 2 – CASE TEMPERATURE (see Note 1 and Figure 4)

PACKAGE	$T_C \leq 25^\circ\text{C}$ POWER RATING	DERATING FACTOR ABOVE $T_C = 25^\circ\text{C}$	$T_C = 70^\circ\text{C}$ POWER RATING	$T_C = 85^\circ\text{C}$ POWER RATING	$T_C = 125^\circ\text{C}$ POWER RATING
D	2063 mW	16.5 mW/°C	1320 mW	1073 mW	413 mW
P	2738 mW	20.49 mW/°C	1816 mW	1508 mW	689 mW
PW	2900 mW	23.2 mW/°C	1856 mW	1508 mW	580 mW

NOTE 1: Dissipation rating tables and figures are provided for maintenance of junction temperature at or below absolute maximum of 150°C. For guidelines on maintaining junction temperature within the recommended operating range, see application information section.

**MAXIMUM CONTINUOUS DISSIPATION
 vs
 FREE-AIR TEMPERATURE**

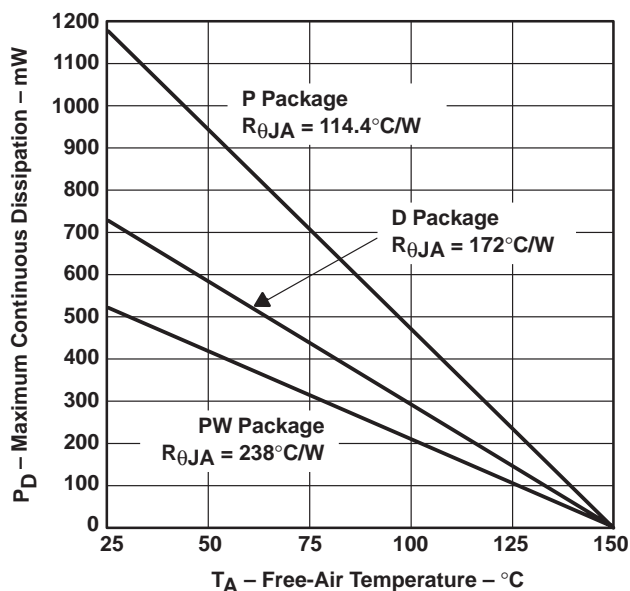

Figure 3

**MAXIMUM CONTINUOUS DISSIPATION
 vs
 CASE TEMPERATURE**

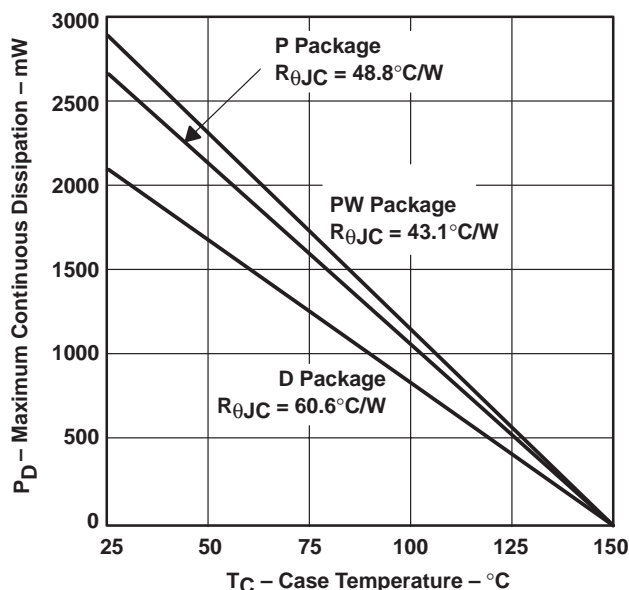

Figure 4



TPS7201Q, TPS7225Q, TPS7230Q
 TPS7233Q, TPS7248Q, TPS7250Q, TPS72xxY
MICROPOWER LOW-DROPOUT (LDO) VOLTAGE REGULATORS
 SLVS102G – MARCH 1995 – REVISED JUNE 2000

recommended operating conditions

		MIN	MAX	UNIT
Input voltage, V_I^\dagger	TPS7201Q	3	10	V
	TPS7225Q	3.65	10	
	TPS7230Q	3.96	10	
	TPS7233Q	3.98	10	
	TPS7248Q	5.24	10	
	TPS7250Q	5.41	10	
High-level input voltage at \overline{EN} , V_{IH}		2		V
Low-level input voltage at \overline{EN} , V_{IL}			0.5	V
Output current, I_O		0	250	mA
Operating virtual junction temperature, T_J		-40	125	°C

[†] Minimum input voltage defined in the recommended operating conditions is the maximum specified output voltage plus dropout voltage at the maximum specified load range. Since dropout voltage is a function of output current, *the usable range can be extended for lighter loads*. To calculate the minimum input voltage for the maximum load current used in a given application, use the following equation:

$$V_{I(\min)} = V_{O(\max)} + V_{DO(\max \text{ load})}$$

Because the TPS7201 is programmable, $r_{DS(on)}$ should be used to calculate V_{DO} before applying the above equation. The equation for calculating V_{DO} from $r_{DS(on)}$ is given in Note 3 under the TPS7201 electrical characteristics table. The minimum value of 3 V is the absolute lower limit for the recommended input-voltage range for the TPS7201.

TPS7201Q, TPS7225Q, TPS7230Q
 TPS7233Q, TPS7248Q, TPS7250Q, TPS72xxY
 MICROPPOWER LOW-DROPOUT (LDO) VOLTAGE REGULATORS

SLVS102G – MARCH 1995 – REVISED JUNE 2000

electrical characteristics, $I_O = 10 \text{ mA}$, $\overline{EN} = 0 \text{ V}$, $C_O = 4.7 \mu\text{F}$ ($\text{CSR}^\dagger = 1 \Omega$), SENSE/FB shorted to OUT (unless otherwise noted)

PARAMETER	TEST CONDITIONS‡	T _J	TPS72xxQ			UNIT
			MIN	TYP	MAX	
Ground current (active mode)	$EN \leq 0.5 \text{ V}$, $0 \text{ mA} \leq I_O \leq 250 \text{ mA}$	$V_I = V_O + 1 \text{ V}$, 25°C	180	225	μA	
		-40°C to 125°C	325			
Input current (standby mode)	$\overline{EN} = V_I$, $3 \text{ V} \leq V_I \leq 10 \text{ V}$	25°C	0.5		μA	
		-40°C to 125°C	1			
Output current limit threshold	$V_O = 0 \text{ V}$ $V_I = 10 \text{ V}$	25°C	0.6	1	A	
		-40°C to 125°C	1.5			
Pass-element leakage current in standby mode	$EN = V_I$, $3 \text{ V} \leq V_I \leq 10 \text{ V}$	25°C	0.5		μA	
		-40°C to 125°C	1			
PG leakage current	$V_{PG} = 10 \text{ V}$, Normal operation	25°C	0.5		μA	
		-40°C to 125°C	0.5			
Output voltage temperature coefficient		-40°C to 125°C	31	75	ppm/°C	
Thermal shutdown junction temperature			165		°C	
\overline{EN} logic high (standby mode)	$3 \text{ V} \leq V_I \leq 6 \text{ V}$	-40°C to 125°C	2		V	
	$6 \text{ V} \leq V_I \leq 10 \text{ V}$		2.7			
\overline{EN} logic low (active mode)	$3 \text{ V} \leq V_I \leq 10 \text{ V}$	25°C	0.5		V	
		-40°C to 125°C	0.5			
\overline{EN} hysteresis voltage		25°C	50		mV	
\overline{EN} input current	$0 \text{ V} \leq V_I \leq 10 \text{ V}$	25°C	-0.5	0.5	μA	
		-40°C to 125°C	-0.5	0.5		
Minimum V_I for active pass element		25°C	1.9	2.5	V	
		-40°C to 125°C	2.5			
Minimum V_I for valid PG	$I_{PG} = 300 \mu\text{A}$	25°C	1.1	1.5	V	
		-40°C to 125°C	1.9			

† CSR(compensation series resistance) refers to the total series resistance, including the equivalent series resistance (ESR) of the capacitor, any series resistance added externally, and PWB trace resistance to C_O .

‡ Pulse-testing techniques are used to maintain virtual junction temperature as close as possible to ambient temperature; thermal effects must be taken into account separately.



TPS7201Q, TPS7225Q, TPS7230Q
TPS7233Q, TPS7248Q, TPS7250Q, TPS72xxY
MICROPOWER LOW-DROPOUT (LDO) VOLTAGE REGULATORS

SLVS102G – MARCH 1995 – REVISED JUNE 2000

TPS7201Q electrical characteristics, $I_O = 10$ mA, $V_I = 3.5$ V, $\overline{EN} = 0$ V, $C_O = 4.7$ μ F (CSR $\dagger = 1$ Ω), FB shorted to OUT at device leads (unless otherwise noted)

PARAMETER	TEST CONDITIONS \ddagger		T _J	TPS7201Q			UNIT
				MIN	TYP	MAX	
Reference voltage (measured at FB with OUT connected to FB)	$V_I = 3.5$ V,	$I_O = 10$ mA	25°C	1.188			V
	3 V $\leq V_I \leq 10$ V, See Note 2	5 mA $\leq I_O \leq 250$ mA,	-40°C to 125°C	1.152	1.224		V
Reference voltage temperature coefficient			-40°C to 125°C	31	75		ppm/°C
Pass-element series resistance (see Note 3)	$V_I = 2.4$ V, \S	50 μ A $\leq I_O \leq 100$ mA	25°C	2.1			Ω
	$V_I = 2.4$ V, \S	100 mA $\leq I_O \leq 200$ mA	25°C	2.9			
	$V_I = 2.9$ V,	50 μ A $\leq I_O \leq 250$ mA	25°C	1.6	2.7		
			-40°C to 125°C	4.5			
	$V_I = 3.9$ V,	50 μ A $\leq I_O \leq 250$ mA	25°C	1			
	$V_I = 5.9$ V,	50 μ A $\leq I_O \leq 250$ mA	25°C	0.8			
Input regulation	$V_I = 3$ V to 10 V, See Note 2	50 μ A $\leq I_O \leq 250$ mA,	25°C	23			mV
			-40°C to 125°C	36			
Output regulation	$I_O = 5$ mA to 250 mA, See Note 2	3 V $\leq V_I \leq 10$ V,	25°C	15	25		mV
			-40°C to 125°C	36			
	$I_O = 50$ μ A to 250 mA, See Note 2	3 V $\leq V_I \leq 10$ V,	25°C	17	27		
			-40°C to 125°C	43			
Ripple rejection	f = 120 Hz	$I_O = 50$ μ A	25°C	49	60		dB
			-40°C to 125°C	32			
		$I_O = 250$ mA, See Note 2	25°C	45	50		
			-40°C to 125°C	30			
Output noise spectral density	f = 120 Hz		25°C	2			μ V/ $\sqrt{\text{Hz}}$
Output noise voltage	10 Hz $\leq f \leq 100$ kHz, CSR $\dagger = 1$ Ω	$C_O = 4.7$ μ F	25°C	235			μ Vrms
		$C_O = 10$ μ F	25°C	190			
		$C_O = 100$ μ F	25°C	125			
PG trip-threshold voltage \P	V _{FB} voltage decreasing from above V _{PG}		-40°C to 125°C	0.95 \times V _{FB(nom)}			V
PG hysteresis voltage \P	Measured at V _{FB}		25°C	12			mV
PG output low voltage \P	I _{PG} = 400 μ A,	$V_I = 2.13$ V	25°C	0.1	0.4		V
			-40°C to 125°C	0.4			
FB input current			25°C	-10	0.1	10	nA
			-40°C to 125°C	-20	20		

\dagger CSR refers to the total series resistance, including the ESR of the capacitor, any series resistance added externally, and PWB trace resistance to C_O.

\ddagger Pulse-testing techniques are used to maintain virtual junction temperature as close as possible to ambient temperature; thermal effects must be taken into account separately.

\S This voltage is not recommended.

\P Output voltage programmed to 2.5 V with closed-loop configuration (see application information).

NOTES: 2. When $V_I < 2.9$ V and $I_O > 100$ mA simultaneously, pass element r_{DS(on)} increases (see Figure 10) to a point such that the resulting dropout voltage prevents the regulator from maintaining the specified tolerance range.

3. To calculate dropout voltage, use equation:

$$V_{DO} = I_O \cdot r_{DS(on)}$$

r_{DS(on)} is a function of both output current and input voltage. The parametric table lists r_{DS(on)} for V_I = 2.4 V, 2.9 V, 3.9 V, and 5.9 V, which corresponds to dropout conditions for programmed output voltages of 2.5 V, 3 V, 4 V, and 6 V, respectively. For other programmed values, refer to Figures 10 and 11.

TPS7201Q, TPS7225Q, TPS7230Q
 TPS7233Q, TPS7248Q, TPS7250Q, TPS72xxY
MICROPOWER LOW-DROPOUT (LDO) VOLTAGE REGULATORS

SLVS102G – MARCH 1995 – REVISED JUNE 2000

TPS7225Q electrical characteristics, $I_O = 10\text{ mA}$, $V_I = 3.5\text{ V}$, $\overline{EN} = 0\text{ V}$, $C_O = 4.7\text{ }\mu\text{F}$ ($CSR^\dagger = 1\text{ }\Omega$), SENSE shorted to OUT (unless otherwise noted)

PARAMETER	TEST CONDITIONS‡		T _J	TPS7225Q			UNIT
				MIN	TYP	MAX	
Output voltage	$V_I = 3.5\text{ V}$,	$I_O = 10\text{ mA}$	25°C	2.5			V
	$3.5\text{ V} \leq V_I \leq 10\text{ V}$,	$5\text{ mA} \leq I_O \leq 250\text{ mA}$	-40°C to 125°C	2.45	2.55		
Dropout voltage	$I_O = 250\text{ mA}$,	$V_I = 2.97\text{ V}$	25°C	560	850		mV
			-40°C to 125°C	1.1			V
Pass-element series resistance	$(2.97\text{ V} - V_O)/I_O$,	$V_I = 2.97\text{ V}$,	25°C	2.24	3.4		Ω
			-40°C to 125°C	3.84			
Input regulation	$V_I = 3.5\text{ V to }10\text{ V}$,	$50\text{ }\mu\text{A} \leq I_O \leq 250\text{ mA}$	25°C	9	27		mV
			-40°C to 125°C	33			
Output regulation	$I_O = 5\text{ mA to }250\text{ mA}$,	$3.5\text{ V} \leq V_I \leq 10\text{ V}$	25°C	28	36		mV
			-40°C to 125°C	60			
	$I_O = 50\text{ }\mu\text{A to }250\text{ mA}$,	$3.5\text{ V} \leq V_I \leq 10\text{ V}$	25°C	24	41		
			-40°C to 125°C	73			
Ripple rejection	$f = 120\text{ Hz}$	$I_O = 50\text{ }\mu\text{A}$	25°C	47	58		dB
			-40°C to 125°C	45			
		$I_O = 250\text{ mA}$	25°C	40	46		
			-40°C to 125°C	38			
Output noise spectral density	$f = 120\text{ Hz}$		25°C	2		$\mu\text{V}/\sqrt{\text{Hz}}$	
Output noise voltage	$10\text{ Hz} \leq f \leq 100\text{ kHz}$,	$CSR^\dagger = 1\text{ }\Omega$	$C_O = 4.7\text{ }\mu\text{F}$	25°C	248		μV_{rms}
			$C_O = 10\text{ }\mu\text{F}$	25°C	200		
			$C_O = 100\text{ }\mu\text{F}$	25°C	130		
PG trip-threshold voltage	V_O voltage decreasing from above V_{PG}		-40°C to 125°C	$0.95 \times V_{O(\text{nom})}$		V	
PG hysteresis voltage			25°C	50		mV	
PG output low voltage	$I_{\text{PG}} = 1.2\text{ mA}$,	$V_I = 2.13\text{ V}$	25°C	0.3	0.44		V
			-40°C to 125°C	0.5			

† CSR refers to the total series resistance, including the ESR of the capacitor, any series resistance added externally, and PWB trace resistance to C_O .

‡ Pulse-testing techniques are used to maintain virtual junction temperature as close as possible to ambient temperature; thermal effects must be taken into account separately.

TPS7201Q, TPS7225Q, TPS7230Q
 TPS7233Q, TPS7248Q, TPS7250Q, TPS72xxY
MICROPOWER LOW-DROPOUT (LDO) VOLTAGE REGULATORS

SLVS102G – MARCH 1995 – REVISED JUNE 2000

TPS7230Q electrical characteristics, $I_O = 10\text{ mA}$, $V_I = 4\text{ V}$, $\overline{EN} = 0\text{ V}$, $C_O = 4.7\text{ }\mu\text{F}$ ($\text{CSR}^\dagger = 1\text{ }\Omega$), SENSE shorted to OUT (unless otherwise noted)

PARAMETER	TEST CONDITIONS [‡]		T _J	TPS7230Q			UNIT
				MIN	TYP	MAX	
Output voltage	$V_I = 4\text{ V}$,	$I_O = 10\text{ mA}$	25°C	3			V
	$4\text{ V} \leq V_I \leq 10\text{ V}$,	$5\text{ mA} \leq I_O \leq 250\text{ mA}$	-40°C to 125°C	2.94	3.06		
Dropout voltage	$I_O = 100\text{ mA}$,	$V_I = 2.97\text{ V}$	25°C	145	185		mV
			-40°C to 125°C	270			
	$I_O = 250\text{ mA}$,	$V_I = 2.97\text{ V}$	25°C	390	502		
			-40°C to 125°C	900			
Pass-element series resistance	$(2.97\text{ V} - V_O)/I_O$,	$V_I = 2.97\text{ V}$,	25°C	1.56	2.01		Ω
			$I_O = 250\text{ mA}$	3.6			
Input regulation	$V_I = 4\text{ V}$ to 10 V,	$50\text{ }\mu\text{A} \leq I_O \leq 250\text{ mA}$	25°C	9	27		mV
			-40°C to 125°C	33			
Output regulation	$I_O = 5\text{ mA}$ to 250 mA,	$4\text{ V} \leq V_I \leq 10\text{ V}$	25°C	34	45		mV
			-40°C to 125°C	74			
	$I_O = 50\text{ }\mu\text{A}$ to 250 mA,	$4\text{ V} \leq V_I \leq 10\text{ V}$	25°C	42	60		
			-40°C to 125°C	98			
Ripple rejection	$f = 120\text{ Hz}$	$I_O = 50\text{ }\mu\text{A}$	25°C	45	56		dB
			-40°C to 125°C	44			
		$I_O = 250\text{ mA}$	25°C	40	45		
			-40°C to 125°C	38			
Output noise spectral density	$f = 120\text{ Hz}$		25°C	2		$\mu\text{V}/\sqrt{\text{Hz}}$	
Output noise voltage	$10\text{ Hz} \leq f \leq 100\text{ kHz}$,	$\text{CSR}^\dagger = 1\text{ }\Omega$	25°C	256		μV_{rms}	
			25°C	206			
			25°C	132			
PG trip-threshold voltage	V_O voltage decreasing from above V_{PG}		-40°C to 125°C	$0.95 \times V_{O(\text{nom})}$		V	
PG hysteresis voltage			25°C	50		mV	
PG output low voltage	$I_{\text{PG}} = 1.2\text{ mA}$,	$V_I = 2.55\text{ V}$	25°C	0.25	0.44		V
			-40°C to 125°C	0.44			

[†] CSR refers to the total series resistance, including the ESR of the capacitor, any series resistance added externally, and PWB trace resistance to C_O .

[‡] Pulse-testing techniques are used to maintain virtual junction temperature as close as possible to ambient temperature; thermal effects must be taken into account separately.

TPS7201Q, TPS7225Q, TPS7230Q
 TPS7233Q, TPS7248Q, TPS7250Q, TPS72xxY
 MICROPPOWER LOW-DROPOUT (LDO) VOLTAGE REGULATORS

SLVS102G – MARCH 1995 – REVISED JUNE 2000

TPS7233Q electrical characteristics, $I_O = 10\text{ mA}$, $V_I = 4.3\text{ V}$, $\overline{EN} = 0\text{ V}$, $C_O = 4.7\text{ }\mu\text{F}$ ($CSR^\dagger = 1\text{ }\Omega$), SENSE shorted to OUT (unless otherwise noted)

PARAMETER	TEST CONDITIONS‡		T _J	TPS7233Q			UNIT
				MIN	TYP	MAX	
Output voltage	$V_I = 4.3\text{ V}$,	$I_O = 10\text{ mA}$	25°C	3.3			V
	$4.3\text{ V} \leq V_I \leq 10\text{ V}$,	$5\text{ mA} \leq I_O \leq 250\text{ mA}$	-40°C to 125°C	3.23	3.37		
Dropout voltage	$I_O = 10\text{ mA}$,	$V_I = 3.23\text{ V}$	25°C	14		20	mV
			-40°C to 125°C			30	
	$I_O = 100\text{ mA}$,	$V_I = 3.23\text{ V}$	25°C	140		180	
			-40°C to 125°C			232	
	$I_O = 250\text{ mA}$,	$V_I = 3.23\text{ V}$	25°C	360		460	
			-40°C to 125°C			610	
Pass-element series resistance	$(3.23\text{ V} - V_O)/I_O$,	$V_I = 3.23\text{ V}$,	25°C	1.5		1.84	Ω
			$I_O = 250\text{ mA}$	-40°C to 125°C			
Input regulation	$V_I = 4.3\text{ V}$ to 10 V,	$50\text{ }\mu\text{A} \leq I_O \leq 250\text{ mA}$	25°C	8		25	mV
			-40°C to 125°C			33	
Output regulation	$I_O = 5\text{ mA}$ to 250 mA,	$4.3\text{ V} \leq V_I \leq 10\text{ V}$	25°C	32		42	mV
			-40°C to 125°C			71	
	$I_O = 50\text{ }\mu\text{A}$ to 250 mA,	$4.3\text{ V} \leq V_I \leq 10\text{ V}$	25°C	41		55	
			-40°C to 125°C			98	
Ripple rejection	$f = 120\text{ Hz}$	$I_O = 50\text{ }\mu\text{A}$	25°C	40	52		dB
			-40°C to 125°C			38	
		$I_O = 250\text{ mA}$	25°C	35	44		
			-40°C to 125°C			33	
Output noise spectral density	$f = 120\text{ Hz}$		25°C	2		$\mu\text{V}/\sqrt{\text{Hz}}$	
Output noise voltage	$10\text{ Hz} \leq f \leq 100\text{ kHz}$,	$CSR^\dagger = 1\text{ }\Omega$	$C_O = 4.7\text{ }\mu\text{F}$	25°C		265	μV_{rms}
			$C_O = 10\text{ }\mu\text{F}$	25°C		212	
			$C_O = 100\text{ }\mu\text{F}$	25°C		135	
PG trip-threshold voltage	V_O voltage decreasing from above V_{PG}		-40°C to 125°C	$0.95 \times V_{O(\text{nom})}$		V	
PG hysteresis voltage			25°C	32		mV	
PG output low voltage	$I_{\text{PG}} = 1.2\text{ mA}$,	$V_I = 2.8\text{ V}$	25°C	0.22		0.4	V
			-40°C to 125°C			0.4	

† CSR refers to the total series resistance, including the ESR of the capacitor, any series resistance added externally, and PWB trace resistance to C_O .

‡ Pulse-testing techniques are used to maintain virtual junction temperature as close as possible to ambient temperature; thermal effects must be taken into account separately.



TPS7201Q, TPS7225Q, TPS7230Q
 TPS7233Q, TPS7248Q, TPS7250Q, TPS72xxY
MICROPOWER LOW-DROPOUT (LDO) VOLTAGE REGULATORS

SLVS102G – MARCH 1995 – REVISED JUNE 2000

TPS7248Q electrical characteristics, $I_O = 10\text{ mA}$, $V_I = 5.85\text{ V}$, $\overline{EN} = 0\text{ V}$, $C_O = 4.7\text{ }\mu\text{F}$ ($\text{CSR}^\dagger = 1\text{ }\Omega$), SENSE shorted to OUT (unless otherwise noted)

PARAMETER	TEST CONDITIONS [‡]		T _J	TPS7248Q			UNIT
				MIN	TYP	MAX	
Output voltage	$V_I = 5.85\text{ V}$,	$I_O = 10\text{ mA}$	25°C	4.85			V
	$5.85\text{ V} \leq V_I \leq 10\text{ V}$,	$5\text{ mA} \leq I_O \leq 250\text{ mA}$	-40°C to 125°C	4.75	4.95		
Dropout voltage	$I_O = 10\text{ mA}$,	$V_I = 4.75\text{ V}$	25°C	10		19	mV
			-40°C to 125°C	30			
	$I_O = 100\text{ mA}$,	$V_I = 4.75\text{ V}$	25°C	90		100	
			-40°C to 125°C	150			
	$I_O = 250\text{ mA}$,	$V_I = 4.75\text{ V}$	25°C	216		250	
			-40°C to 125°C	285			
Pass-element series resistance	$(4.75\text{ V} - V_O)/I_O$,	$V_I = 4.75\text{ V}$,	25°C	0.8		1	Ω
			$I_O = 250\text{ mA}$	1.4			
Input regulation	$V_I = 5.85\text{ V}$ to 10 V,	$50\text{ }\mu\text{A} \leq I_O \leq 250\text{ mA}$	25°C	34		mV	
			-40°C to 125°C	50			
Output regulation	$I_O = 5\text{ mA}$ to 250 mA,	$5.85\text{ V} \leq V_I \leq 10\text{ V}$	25°C	43		55	mV
			-40°C to 125°C	95			
	$I_O = 50\text{ }\mu\text{A}$ to 250 mA,	$5.85\text{ V} \leq V_I \leq 10\text{ V}$	25°C	55		75	
			-40°C to 125°C	135			
Ripple rejection	$f = 120\text{ Hz}$	$I_O = 50\text{ }\mu\text{A}$	25°C	42		53	dB
			-40°C to 125°C	36			
		$I_O = 250\text{ mA}$	25°C	36		46	
			-40°C to 125°C	34			
Output noise spectral density	$f = 120\text{ Hz}$		25°C	2		$\mu\text{V}/\sqrt{\text{Hz}}$	
Output noise voltage	$10\text{ Hz} \leq f \leq 100\text{ kHz}$,	$\text{CSR}^\dagger = 1\text{ }\Omega$	25°C	370		μV_{rms}	
			25°C	290			
			25°C	168			
PG trip-threshold voltage	V_O voltage decreasing from above V_{PG}		-40°C to 125°C	$0.95 \times V_{O(\text{nom})}$		V	
PG hysteresis voltage			25°C	50		mV	
PG output low voltage	$I_{\text{PG}} = 1.2\text{ mA}$,	$V_I = 4.12\text{ V}$	25°C	0.2		0.4	V
			-40°C to 125°C	0.4			

[†] CSR refers to the total series resistance, including the ESR of the capacitor, any series resistance added externally, and PWB trace resistance to C_O .

[‡] Pulse-testing techniques are used to maintain virtual junction temperature as close as possible to ambient temperature; thermal effects must be taken into account separately.

TPS7201Q, TPS7225Q, TPS7230Q
 TPS7233Q, TPS7248Q, TPS7250Q, TPS72xxY
MICROPOWER LOW-DROPOUT (LDO) VOLTAGE REGULATORS

SLVS102G – MARCH 1995 – REVISED JUNE 2000

TPS7250Q electrical characteristics, $I_O = 10\text{ mA}$, $V_I = 6\text{ V}$, $\overline{EN} = 0\text{ V}$, $C_O = 4.7\text{ }\mu\text{F}$ ($CSR^\dagger = 1\text{ }\Omega$), SENSE shorted to OUT (unless otherwise noted)

PARAMETER	TEST CONDITIONS‡	T _J	TPS7250Q			UNIT	
			MIN	TYP	MAX		
Output voltage	$V_I = 6\text{ V}$, $I_O = 10\text{ mA}$	25°C	5			V	
	$6\text{ V} \leq V_I \leq 10\text{ V}$, $5\text{ mA} \leq I_O \leq 250\text{ mA}$	-40°C to 125°C	4.9	5.1			
Dropout voltage	$I_O = 10\text{ mA}$, $V_I = 4.88\text{ V}$	25°C	8			mV	
		-40°C to 125°C	30				
	$I_O = 100\text{ mA}$, $V_I = 4.88\text{ V}$	25°C	76				
		-40°C to 125°C	136				
	$I_O = 250\text{ mA}$, $V_I = 4.88\text{ V}$	25°C	190				
		-40°C to 125°C	312				
Pass-element series resistance	$(4.88\text{ V} - V_O)/I_O$, $I_O = 250\text{ mA}$, $V_I = 4.88\text{ V}$	25°C	0.76	0.825		Ω	
		-40°C to 125°C	1.25				
Input regulation	$V_I = 6\text{ V to }10\text{ V}$, $50\text{ }\mu\text{A} \leq I_O \leq 250\text{ mA}$	25°C	28			mV	
		-40°C to 125°C	35				
Output regulation	$I_O = 5\text{ mA to }250\text{ mA}$, $6\text{ V} \leq V_I \leq 10\text{ V}$	25°C	46	61		mV	
		-40°C to 125°C	100				
	$I_O = 50\text{ }\mu\text{A to }250\text{ mA}$, $6\text{ V} \leq V_I \leq 10\text{ V}$	25°C	59	79			
		-40°C to 125°C	150				
Ripple rejection	$f = 120\text{ Hz}$	$I_O = 50\text{ }\mu\text{A}$	25°C	41	52		dB
			-40°C to 125°C	37			
		$I_O = 250\text{ mA}$	25°C	36	46		
			-40°C to 125°C	32			
Output noise spectral density	$f = 120\text{ Hz}$	25°C	2			$\mu\text{V}/\sqrt{\text{Hz}}$	
Output noise voltage	$10\text{ Hz} \leq f \leq 100\text{ kHz}$, $CSR^\dagger = 1\text{ }\Omega$	$C_O = 4.7\text{ }\mu\text{F}$	25°C	390		μV_{rms}	
		$C_O = 10\text{ }\mu\text{F}$	25°C	300			
		$C_O = 100\text{ }\mu\text{F}$	25°C	175			
PG trip-threshold voltage	V_O voltage decreasing from above V_{PG}	-40°C to 125°C	$0.95 \times V_{O(\text{nom})}$			V	
PG hysteresis voltage		25°C	50			mV	
PG output low voltage	$I_{\text{PG}} = 1.2\text{ mA}$, $V_I = 4.25\text{ V}$	25°C	0.19	0.4		V	
		-40°C to 125°C	0.4				

† CSR refers to the total series resistance, including the ESR of the capacitor, any series resistance added externally, and PWB trace resistance to C_O .

‡ Pulse-testing techniques are used to maintain virtual junction temperature as close as possible to ambient temperature; thermal effects must be taken into account separately.



TPS7201Q, TPS7225Q, TPS7230Q
 TPS7233Q, TPS7248Q, TPS7250Q, TPS72xxY
MICROPOWER LOW-DROPOUT (LDO) VOLTAGE REGULATORS

SLVS102G – MARCH 1995 – REVISED JUNE 2000

electrical characteristics, $I_O = 10\text{ mA}$, $\overline{EN} = 0\text{ V}$, $C_O = 4.7\text{ }\mu\text{F}$ ($CSR^\dagger = 1\text{ }\Omega$), $T_J = 25^\circ\text{C}$, SENSE/FB shorted to OUT (unless otherwise noted)

PARAMETER	TEST CONDITIONS‡	TPS72xxY			UNIT
		MIN	TYP	MAX	
Ground current (active mode)	$\overline{EN} \leq 0.5\text{ V}$, $V_I = V_O + 1\text{ V}$, $0\text{ mA} \leq I_O \leq 250\text{ mA}$		180		μA
Output current limit threshold	$V_O = 0\text{ V}$, $V_I = 10\text{ V}$		0.6		A
Thermal shutdown junction temperature			165		$^\circ\text{C}$
\overline{EN} hysteresis voltage			50		mV
Minimum V_I for active pass element			1.9		V
Minimum V_I for valid PG	$I_{PG} = 300\text{ }\mu\text{A}$		1.1		V

electrical characteristics, $I_O = 10\text{ mA}$, $\overline{EN} = 0\text{ V}$, $C_O = 4.7\text{ }\mu\text{F}$ ($CSR^\dagger = 1\text{ }\Omega$), $T_J = 25^\circ\text{C}$, FB shorted to OUT at device leads (unless otherwise noted)

PARAMETER	TEST CONDITIONS‡	TPS7201Y			UNIT
		MIN	TYP	MAX	
Reference voltage (measured at FB with OUT connected to FB)	$V_I = 3.5\text{ V}$, $I_O = 10\text{ mA}$		1.188		V
Pass-element series resistance (see Note 3)	$V_I = 2.4\text{ V}$,§ $50\text{ }\mu\text{A} \leq I_O \leq 100\text{ mA}$		2.1		Ω
	$V_I = 2.4\text{ V}$,§ $100\text{ mA} \leq I_O \leq 200\text{ mA}$		2.9		
	$V_I = 2.9\text{ V}$, $50\text{ }\mu\text{A} \leq I_O \leq 250\text{ mA}$		1.6		
	$V_I = 3.9\text{ V}$, $50\text{ }\mu\text{A} \leq I_O \leq 250\text{ mA}$		1		
	$V_I = 5.9\text{ V}$, $50\text{ }\mu\text{A} \leq I_O \leq 250\text{ mA}$		0.8		
Output regulation	$3\text{ V} \leq V_I \leq 10\text{ V}$, See Note 2, $I_O = 5\text{ mA to } 250\text{ mA}$,		15		mV
	$3\text{ V} \leq V_I \leq 10\text{ V}$, See Note 2, $I_O = 50\text{ }\mu\text{A to } 250\text{ mA}$,		17		
Ripple rejection	$V_I = 3.5\text{ V}$, $f = 120\text{ Hz}$	$I_O = 50\text{ }\mu\text{A}$	60		dB
		$I_O = 250\text{ mA}$, See Note 2	50		
Output noise spectral density	$V_I = 3.5\text{ V}$, $f = 120\text{ Hz}$		2		$\mu\text{V}/\sqrt{\text{Hz}}$
Output noise voltage	$V_I = 3.5\text{ V}$, $10\text{ Hz} \leq f \leq 100\text{ kHz}$, $CSR^\dagger = 1\text{ }\Omega$	$C_O = 4.7\text{ }\mu\text{F}$	235		μV_{rms}
		$C_O = 10\text{ }\mu\text{F}$	190		
		$C_O = 100\text{ }\mu\text{F}$	125		
PG hysteresis voltage¶	$V_I = 3.5\text{ V}$, Measured at V_{FB}		12		mV
PG output low voltage¶	$V_I = 2.13\text{ V}$, $I_{PG} = 400\text{ }\mu\text{A}$		0.1		V
FB input current	$V_I = 3.5\text{ V}$		0.1		nA

† CSR refers to the total series resistance, including the ESR of the capacitor, any series resistance added externally, and PWB trace resistance to C_O .

‡ Pulse-testing techniques are used to maintain virtual junction temperature as close as possible to ambient temperature; thermal effects must be taken into account separately.

§ This voltage is not recommended.

¶ Output voltage programmed to 2.5 V with closed-loop configuration (see application information).

NOTES: 2 When $V_I < 2.9\text{ V}$ and $I_O > 100\text{ mA}$ simultaneously, pass element $r_{DS(on)}$ increases (see Figure 10) to a point such that the resulting dropout voltage prevents the regulator from maintaining the specified tolerance range.

3 To calculate dropout voltage, use equation:

$$V_{DO} = I_O \cdot r_{DS(on)}$$

$r_{DS(on)}$ is a function of both output current and input voltage. The parametric table lists $r_{DS(on)}$ for $V_I = 2.4\text{ V}$, 2.9 V , 3.9 V , and 5.9 V , which corresponds to dropout conditions for programmed output voltages of 2.5 V, 3 V, 4 V, and 6 V, respectively. For other programmed values, refer to Figures 10 and 11.



TPS7201Q, TPS7225Q, TPS7230Q
 TPS7233Q, TPS7248Q, TPS7250Q, TPS72xxY
MICROPOWER LOW-DROPOUT (LDO) VOLTAGE REGULATORS

SLVS102G – MARCH 1995 – REVISED JUNE 2000

electrical characteristics, $I_O = 10\text{ mA}$, $\overline{EN} = 0\text{ V}$, $C_O = 4.7\text{ }\mu\text{F}$ ($\text{CSR}^\dagger = 1\text{ }\Omega$), $T_J = 25^\circ\text{C}$, FB shorted to OUT at device leads (unless otherwise noted)

PARAMETER	TEST CONDITIONS‡	TPS7225Y			UNIT
		MIN	TYP	MAX	
Output voltage	$V_I = 3.5\text{ V}$, $I_O = 10\text{ mA}$		2.5		V
Dropout voltage	$V_I = 2.97\text{ V}$, $I_O = 250\text{ mA}$		560		mV
Pass-element series resistance	$(2.97\text{ V} - V_O)/I_O$, $I_O = 250\text{ mA}$, $V_I = 2.97\text{ V}$		2.24		Ω
Input regulation	$V_I = 3.5\text{ V to }10\text{ V}$, $50\text{ }\mu\text{A} \leq I_O \leq 250\text{ mA}$		9		mV
Output regulation	$3.5\text{ V} \leq V_I \leq 10\text{ V}$, $I_O = 5\text{ mA to }250\text{ mA}$		28		mV
	$3.5\text{ V} \leq V_I \leq 10\text{ V}$, $I_O = 50\text{ }\mu\text{A to }250\text{ mA}$		24		
Ripple rejection	$V_I = 3.5\text{ V}$, $f = 120\text{ Hz}$	$I_O = 50\text{ }\mu\text{A}$	58		dB
		$I_O = 250\text{ mA}$	46		
Output noise spectral density	$V_I = 3.5\text{ V}$, $f = 120\text{ Hz}$		2		$\mu\text{V}/\sqrt{\text{Hz}}$
Output noise voltage	$V_I = 3.5\text{ V}$, $10\text{ Hz} \leq f \leq 100\text{ kHz}$, $\text{CSR}^\dagger = 1\text{ }\Omega$	$C_O = 4.7\text{ }\mu\text{F}$	248		μV_{rms}
		$C_O = 10\text{ }\mu\text{F}$	200		
		$C_O = 100\text{ }\mu\text{F}$	130		
PG hysteresis voltage	$V_I = 3.5\text{ V}$		50		mV
PG output low voltage	$V_I = 2.13\text{ V}$, $I_{\text{PG}} = 1.2\text{ mA}$		0.3		V

† CSR refers to the total series resistance, including the ESR of the capacitor, any series resistance added externally, and PWB trace resistance to C_O .

‡ Pulse-testing techniques are used to maintain virtual junction temperature as close as possible to ambient temperature; thermal effects must be taken into account separately.



TPS7201Q, TPS7225Q, TPS7230Q
 TPS7233Q, TPS7248Q, TPS7250Q, TPS72xxY
MICROPOWER LOW-DROPOUT (LDO) VOLTAGE REGULATORS

SLVS102G – MARCH 1995 – REVISED JUNE 2000

electrical characteristics, $I_O = 10\text{ mA}$, $\overline{EN} = 0\text{ V}$, $C_O = 4.7\text{ }\mu\text{F}$ ($\text{CSR}^\dagger = 1\text{ }\Omega$), $T_J = 25^\circ\text{C}$, SENSE shorted to OUT (unless otherwise noted)

PARAMETER	TEST CONDITIONS [‡]		TPS7230Y			UNIT
			MIN	TYP	MAX	
Output voltage	$V_I = 4\text{ V}$,	$I_O = 10\text{ mA}$		3		V
Dropout voltage	$V_I = 2.97\text{ V}$,	$I_O = 100\text{ mA}$		145		mV
	$V_I = 2.97\text{ V}$,	$I_O = 250\text{ mA}$		390		
Pass-element series resistance	$(2.97\text{ V} - V_O)/I_O$, $I_O = 250\text{ mA}$	$V_I = 2.97\text{ V}$,		1.56		Ω
Input regulation	$V_I = 4\text{ V to }10\text{ V}$,	$50\text{ }\mu\text{A} \leq I_O \leq 250\text{ mA}$		9		mV
Output regulation	$4\text{ V} \leq V_I \leq 10\text{ V}$	$I_O = 5\text{ mA to }250\text{ mA}$		34		mV
	$4\text{ V} \leq V_I \leq 10\text{ V}$	$I_O = 50\text{ }\mu\text{A to }250\text{ mA}$		41		
Ripple rejection	$V_I = 4\text{ V}$, $f = 120\text{ Hz}$	$I_O = 50\text{ }\mu\text{A}$		56		dB
		$I_O = 250\text{ mA}$		45		
Output noise spectral density	$V_I = 4\text{ V}$,	$f = 120\text{ Hz}$		2		$\mu\text{V}/\sqrt{\text{Hz}}$
Output noise voltage	$V_I = 4\text{ V}$, $10\text{ Hz} \leq f \leq 100\text{ kHz}$, $\text{CSR}^\dagger = 1\text{ }\Omega$	$C_O = 4.7\text{ }\mu\text{F}$		256		μV_{rms}
		$C_O = 10\text{ }\mu\text{F}$		206		
		$C_O = 100\text{ }\mu\text{F}$		132		
PG hysteresis voltage	$V_I = 4\text{ V}$			50		mV
PG output low voltage	$V_I = 2.55\text{ V}$	$I_{\text{PG}} = 1.2\text{ mA}$		0.25		V

[†] CSR refers to the total series resistance, including the ESR of the capacitor, any series resistance added externally, and PWB trace resistance to C_O .

[‡] Pulse-testing techniques are used to maintain virtual junction temperature as close as possible to ambient temperature; thermal effects must be taken into account separately.

PARAMETER	TEST CONDITIONS [‡]		TPS7233Y			UNIT
			MIN	TYP	MAX	
Output voltage	$V_I = 4.3\text{ V}$,	$I_O = 10\text{ mA}$		3.3		V
Dropout voltage	$V_I = 3.23\text{ V}$,	$I_O = 10\text{ mA}$		14		mV
	$V_I = 3.23\text{ V}$,	$I_O = 100\text{ mA}$		140		
	$V_I = 3.23\text{ V}$,	$I_O = 250\text{ mA}$		360		
Pass-element series resistance	$(3.23\text{ V} - V_O)/I_O$, $I_O = 250\text{ mA}$	$V_I = 3.23\text{ V}$,		1.5		Ω
Input regulation	$V_I = 4.3\text{ V to }10\text{ V}$,	$50\text{ }\mu\text{A} \leq I_O \leq 250\text{ mA}$		8		mV
Output regulation	$4.3\text{ V} \leq V_I \leq 10\text{ V}$,	$I_O = 5\text{ mA to }250\text{ mA}$		32		mV
	$4.3\text{ V} \leq V_I \leq 10\text{ V}$,	$I_O = 50\text{ }\mu\text{A to }250\text{ mA}$		41		
Ripple rejection	$V_I = 4.3\text{ V}$, $f = 120\text{ Hz}$	$I_O = 50\text{ }\mu\text{A}$		52		dB
		$I_O = 250\text{ mA}$		44		
Output noise spectral density	$V_I = 4.3\text{ V}$,	$f = 120\text{ Hz}$		2		$\mu\text{V}/\sqrt{\text{Hz}}$
Output noise voltage	$V_I = 4.3\text{ V}$, $10\text{ Hz} \leq f \leq 100\text{ kHz}$, $\text{CSR}^\dagger = 1\text{ }\Omega$	$C_O = 4.7\text{ }\mu\text{F}$		265		μV_{rms}
		$C_O = 10\text{ }\mu\text{F}$		212		
		$C_O = 100\text{ }\mu\text{F}$		135		
PG hysteresis voltage	$V_I = 4.3\text{ V}$			32		mV
PG output low voltage	$V_I = 2.8\text{ V}$,	$I_{\text{PG}} = 1.2\text{ mA}$		0.22		V

[†] CSR refers to the total series resistance, including the ESR of the capacitor, any series resistance added externally, and PWB trace resistance to C_O .

[‡] Pulse-testing techniques are used to maintain virtual junction temperature as close as possible to ambient temperature; thermal effects must be taken into account separately.



TPS7201Q, TPS7225Q, TPS7230Q
 TPS7233Q, TPS7248Q, TPS7250Q, TPS72xxY
MICROPOWER LOW-DROPOUT (LDO) VOLTAGE REGULATORS

SLVS102G – MARCH 1995 – REVISED JUNE 2000

electrical characteristics, $I_O = 10\text{ mA}$, $\overline{EN} = 0\text{ V}$, $C_O = 4.7\text{ }\mu\text{F}$ ($\text{CSR}^\dagger = 1\text{ }\Omega$), $T_J = 25^\circ\text{C}$, SENSE shorted to OUT (unless otherwise noted) (continued)

PARAMETER	TEST CONDITIONS‡	TPS7248Y			UNIT
		MIN	TYP	MAX	
Output voltage	$V_I = 5.85\text{ V}$, $I_O = 10\text{ mA}$	4.85			V
Dropout voltage	$V_I = 4.75\text{ V}$, $I_O = 10\text{ mA}$	10			mV
	$V_I = 4.75\text{ V}$, $I_O = 100\text{ mA}$	90			
	$V_I = 4.75\text{ V}$, $I_O = 250\text{ mA}$	216			
Pass-element series resistance	$(4.75\text{ V} - V_O)/I_O$, $I_O = 250\text{ mA}$, $V_I = 4.75\text{ V}$	0.8			Ω
Output regulation	$5.85\text{ V} \leq V_I \leq 10\text{ V}$, $I_O = 5\text{ mA to }250\text{ mA}$	43			mV
	$5.85\text{ V} \leq V_I \leq 10\text{ V}$, $I_O = 50\text{ }\mu\text{A to }250\text{ mA}$	55			
Ripple rejection	$V_I = 5.85\text{ V}$, $f = 120\text{ Hz}$	$I_O = 50\text{ }\mu\text{A}$	53		dB
		$I_O = 250\text{ mA}$	46		
Output noise spectral density	$V_I = 5.85\text{ V}$, $f = 120\text{ Hz}$	2			$\mu\text{V}/\sqrt{\text{Hz}}$
Output noise voltage	$V_I = 5.85\text{ V}$, $10\text{ Hz} \leq f \leq 100\text{ kHz}$, $\text{CSR}^\dagger = 1\text{ }\Omega$	$C_O = 4.7\text{ }\mu\text{F}$	370		μV_{rms}
		$C_O = 10\text{ }\mu\text{F}$	290		
		$C_O = 100\text{ }\mu\text{F}$	168		
PG hysteresis voltage	$V_I = 5.85\text{ V}$	50			mV
PG output low voltage	$V_I = 4.12\text{ V}$, $I_{\text{PG}} = 1.2\text{ mA}$	0.2			V

† CSR refers to the total series resistance, including the ESR of the capacitor, any series resistance added externally, and PWB trace resistance to C_O .

‡ Pulse-testing techniques are used to maintain virtual junction temperature as close as possible to ambient temperature; thermal effects must be taken into account separately.

PARAMETER	TEST CONDITIONS‡	TPS7250Y			UNIT
		MIN	TYP	MAX	
Output voltage	$V_I = 6\text{ V}$, $I_O = 10\text{ mA}$	5			V
Dropout voltage	$V_I = 4.88\text{ V}$, $I_O = 10\text{ mA}$	8			mV
	$V_I = 4.88\text{ V}$, $I_O = 100\text{ mA}$	76			
	$V_I = 4.88\text{ V}$, $I_O = 250\text{ mA}$	190			
Pass-element series resistance	$(4.88\text{ V} - V_O)/I_O$, $I_O = 250\text{ mA}$, $V_I = 4.88\text{ V}$	0.76			Ω
Input regulation	$V_I = 6\text{ V to }10\text{ V}$, $50\text{ }\mu\text{A} \leq I_O \leq 250\text{ mA}$				mV
Output regulation	$6\text{ V} \leq V_I \leq 10\text{ V}$, $I_O = 5\text{ mA to }250\text{ mA}$	46			mV
	$6\text{ V} \leq V_I \leq 10\text{ V}$, $I_O = 50\text{ }\mu\text{A to }250\text{ mA}$	59			
Ripple rejection	$V_I = 6\text{ V}$, $f = 120\text{ Hz}$	$I_O = 50\text{ }\mu\text{A}$	52		dB
		$I_O = 250\text{ mA}$	46		
Output noise spectral density	$V_I = 6\text{ V}$, $f = 120\text{ Hz}$	2			$\mu\text{V}/\sqrt{\text{Hz}}$
Output noise voltage	$V_I = 6\text{ V}$, $10\text{ Hz} \leq f \leq 100\text{ kHz}$, $\text{CSR}^\dagger = 1\text{ }\Omega$	$C_O = 4.7\text{ }\mu\text{F}$	390		μV_{rms}
		$C_O = 10\text{ }\mu\text{F}$	300		
		$C_O = 100\text{ }\mu\text{F}$	175		
PG hysteresis voltage	$V_I = 6\text{ V}$	50			mV
PG output low voltage	$V_I = 4.25\text{ V}$, $I_{\text{PG}} = 1.2\text{ mA}$	0.19			V

† CSR refers to the total series resistance, including the ESR of the capacitor, any series resistance added externally, and PWB trace resistance to C_O .

‡ Pulse-testing techniques are used to maintain virtual junction temperature as close as possible to ambient temperature; thermal effects must be taken into account separately.



TYPICAL CHARACTERISTICS

Table of Graphs

		FIGURE	
I_Q	Quiescent current	vs Output current	5
		vs Input voltage	6
ΔI_Q^\dagger	Change in quiescent current	vs Free-air temperature	7
V_{DO}	Dropout voltage	vs Output current	8
ΔV_{DO}	Change in dropout voltage	vs Free-air temperature	9
V_{DO}	Dropout voltage (TPS7201 only)	vs Output current	10
$r_{DS(on)}$	Pass-element series resistance	vs Input voltage	11
ΔV_O	Change in output voltage	vs Free-air temperature	12
V_O	Output voltage	vs Input voltage	13
	Line regulation (TPS7201, TPS7233, TPS7248, TPS7250)		14
	Load regulation (TPS7225, TPS7233, TPS7248, TPS7250)		15
$V_{O(PG)}$	Power-good (PG) voltage	vs Output voltage	16
$r_{DS(on)PG}$	Power-good (PG) on-resistance	vs Input voltage	17
V_I	Minimum input voltage for valid PG	vs Free-air temperature	18
	Output voltage response from enable (\overline{EN})		19
	Load transient response (TPS7201/TPS7233)		20
	Load transient response (TPS7248/TPS7250)		21
	Line transient response (TPS7201)		22
	Line transient response (TPS7233)		23
	Line transient response (TPS7248/TPS7250)		24
	Ripple rejection	vs Frequency	25
	Output Spectral Noise Density	vs Frequency	26
	Compensation series resistance (CSR)	vs Output current ($C_O = 4.7 \mu F$)	27
		vs Added ceramic capacitance ($C_O = 4.7 \mu F$)	28
		vs Output current ($C_O = 10 \mu F$)	29
		vs Added ceramic capacitance ($C_O = 10 \mu F$)	30

† This symbol is not currently listed within EIA or JEDEC standards for semiconductor symbology.

TYPICAL CHARACTERISTICS

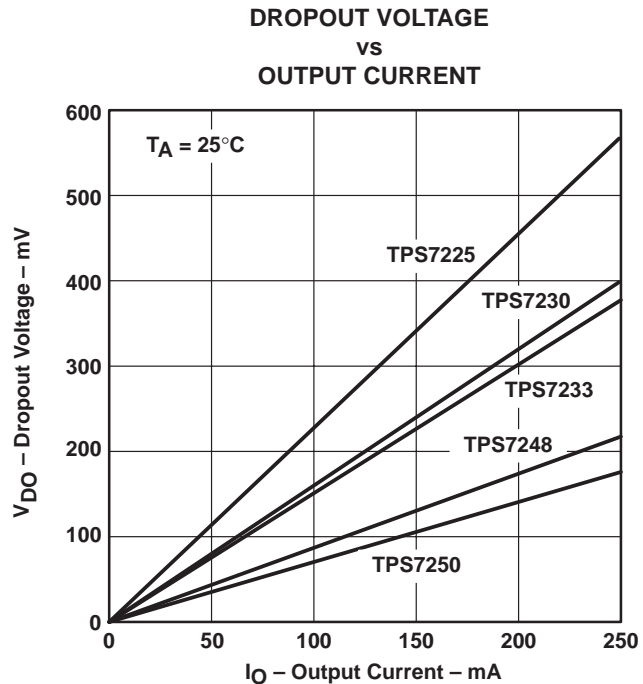
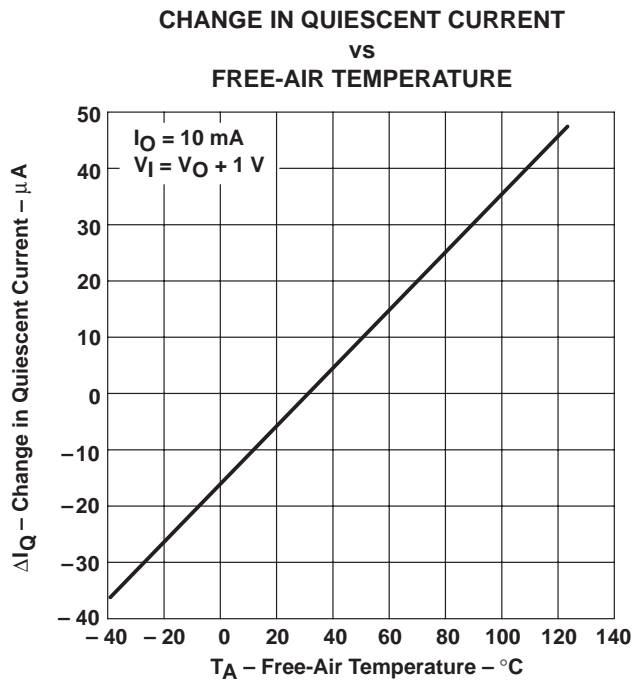
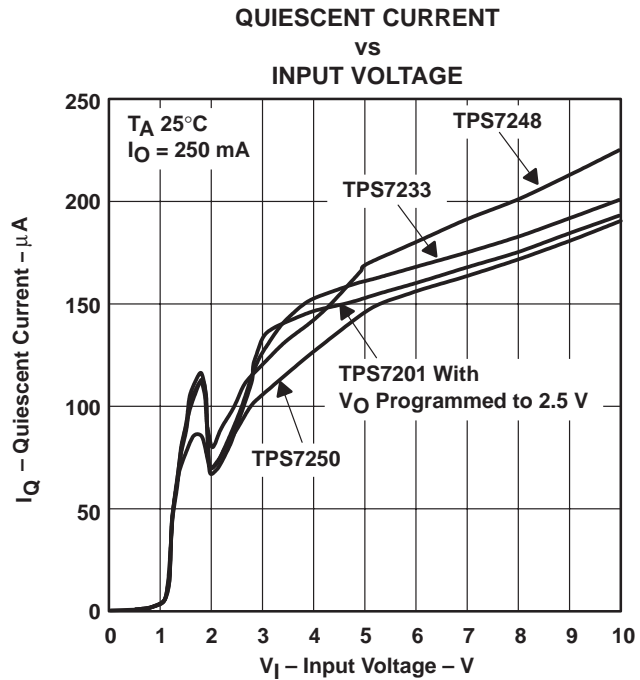
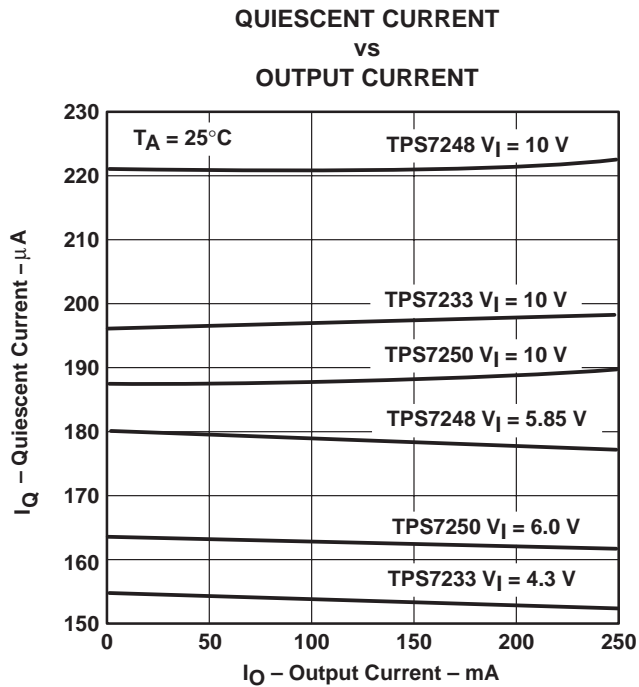

TYPICAL CHARACTERISTICS

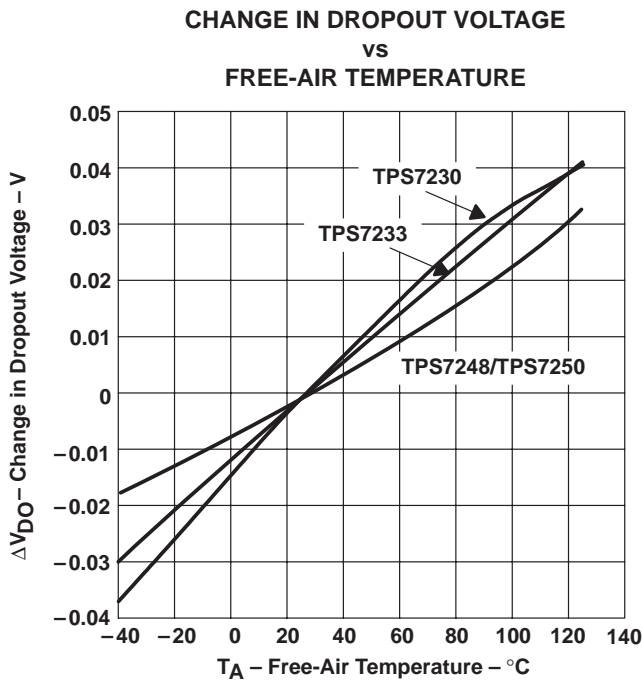
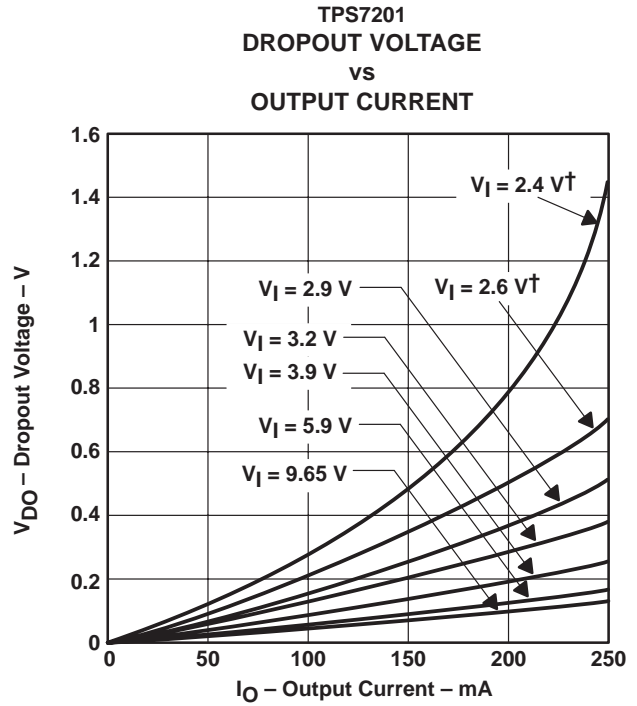

Figure 9



† This voltage is not recommended.

Figure 10

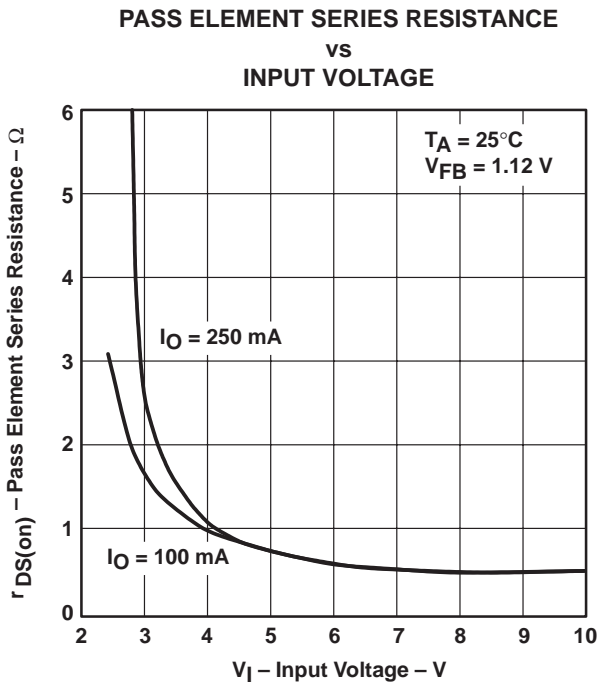

Figure 11

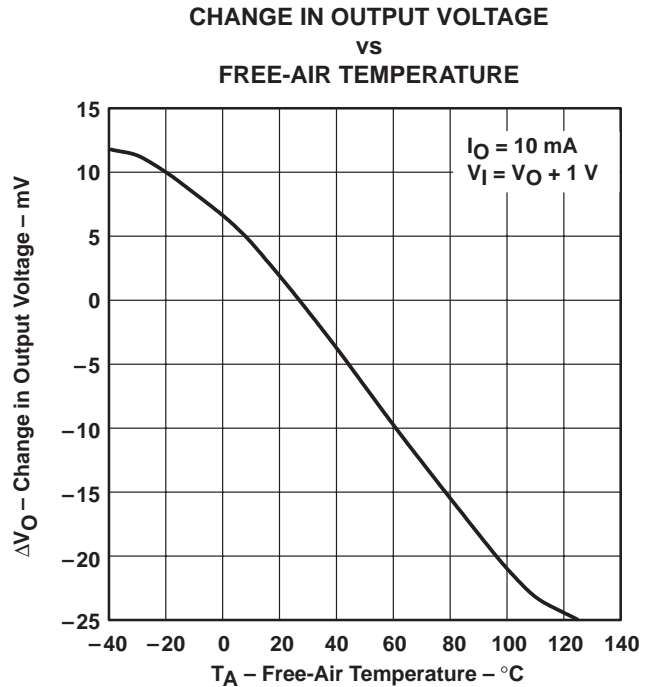

Figure 12

TYPICAL CHARACTERISTICS

OUTPUT VOLTAGE
 vs
 INPUT VOLTAGE

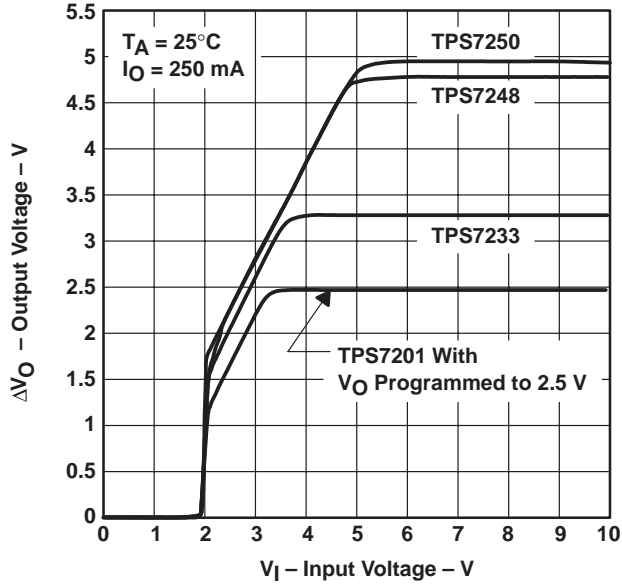

Figure 13

LINE REGULATION

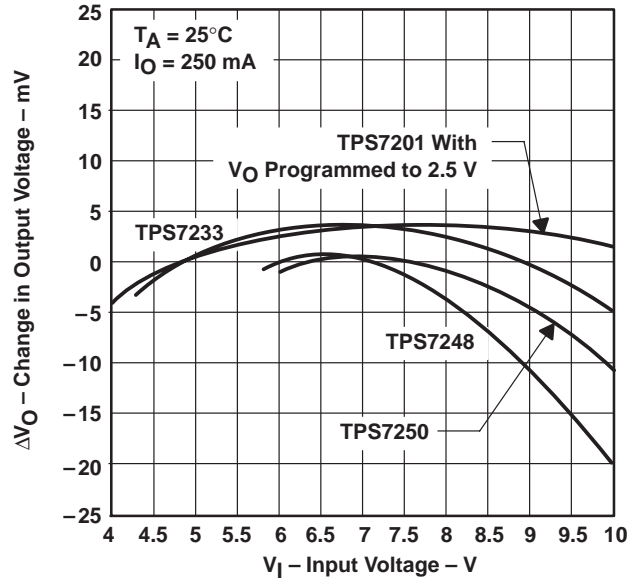

Figure 14

LOAD REGULATION

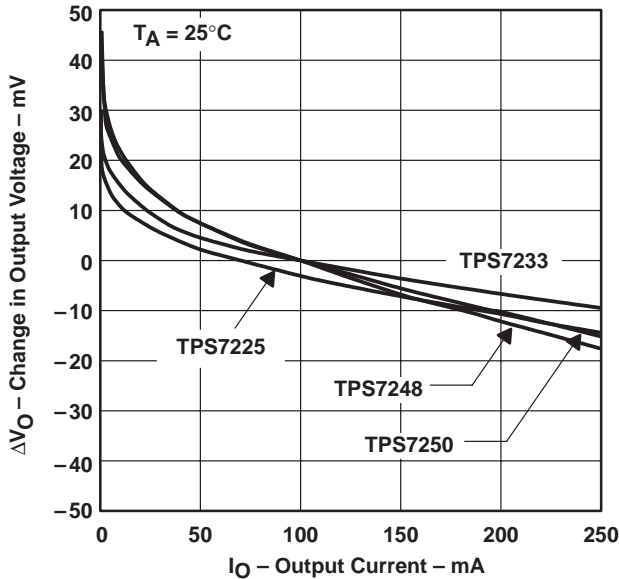
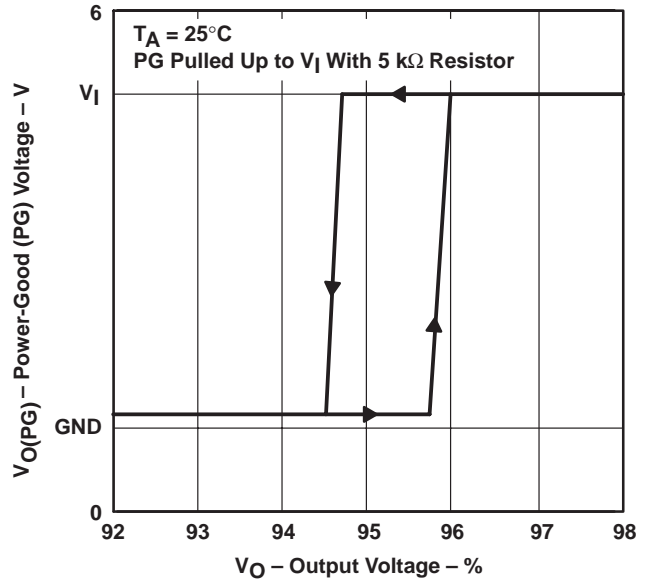

Figure 15

POWER-GOOD (PG) VOLTAGE
 vs
 OUTPUT VOLTAGE†



† V_O as a percent of $V_{O\text{nom}}$.

Figure 16

TYPICAL CHARACTERISTICS

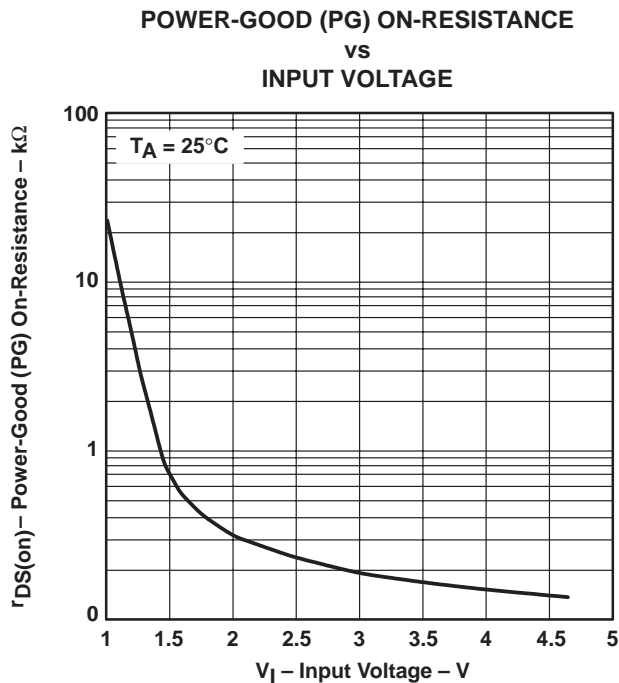

Figure 17

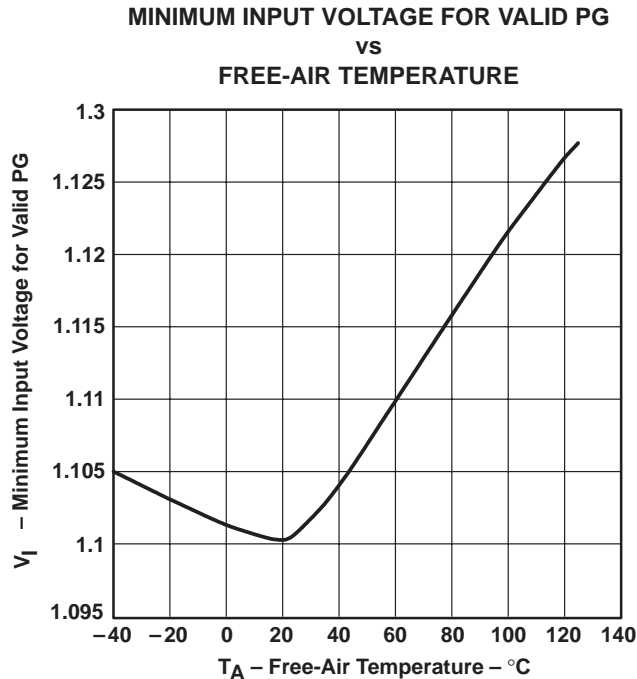

Figure 18

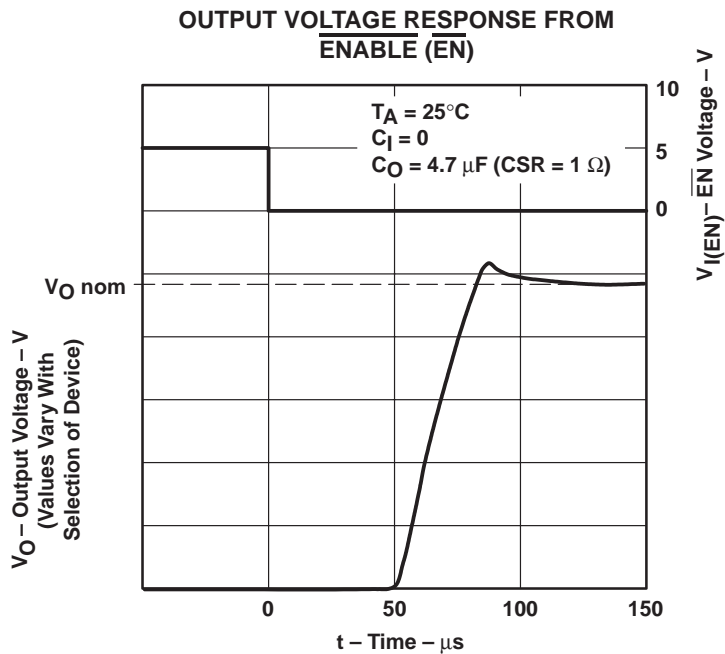

Figure 19

TYPICAL CHARACTERISTICS

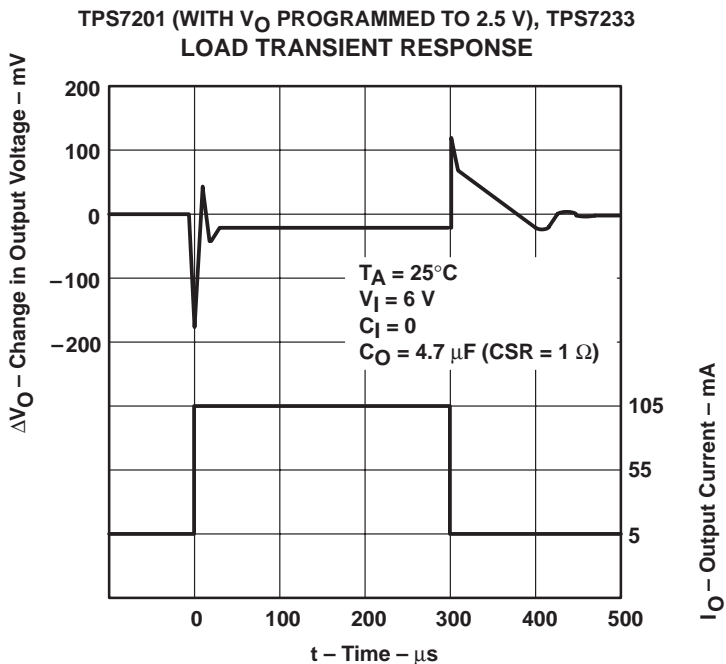

Figure 20

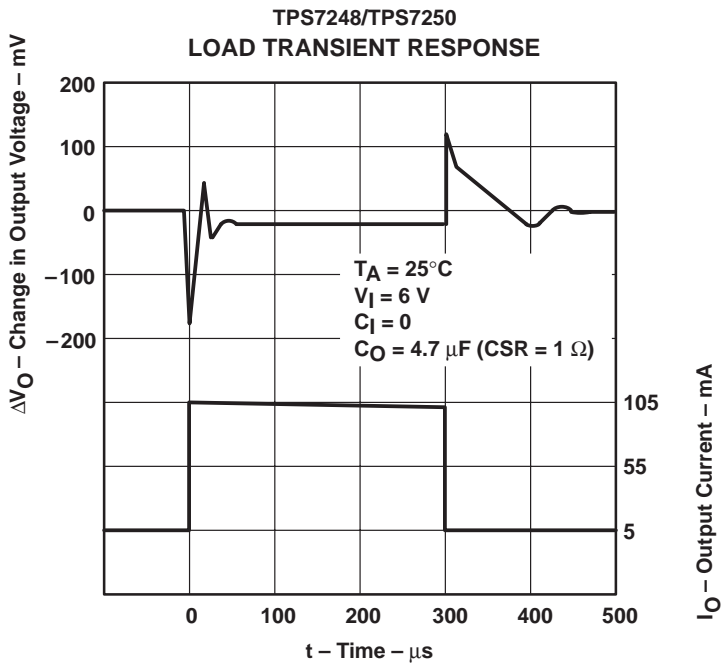

Figure 21

TYPICAL CHARACTERISTICS

TPS7201 WITH V_O PROGRAMMED TO 2.5 V
 LINE TRANSIENT RESPONSE

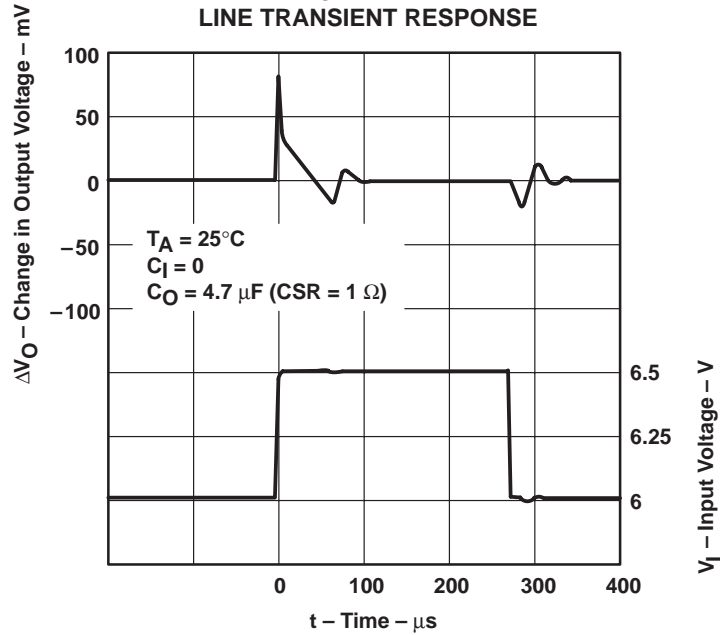

Figure 22

TPS7233
 LINE TRANSIENT RESPONSE

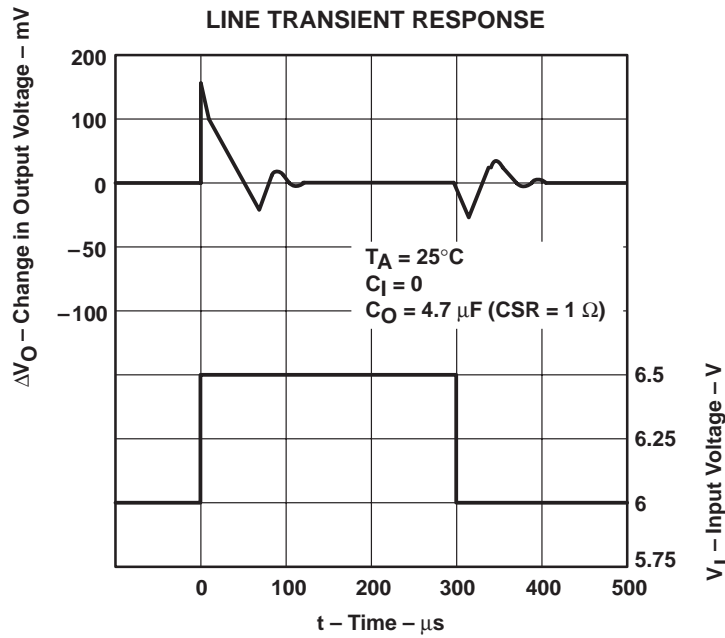

Figure 23

TYPICAL CHARACTERISTICS

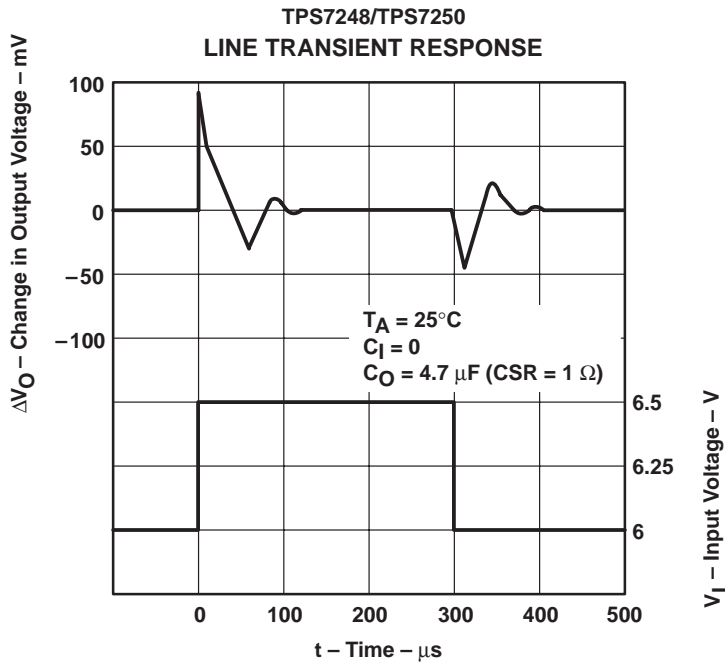

Figure 24

RIPPLE REJECTION
 VS
 FREQUENCY

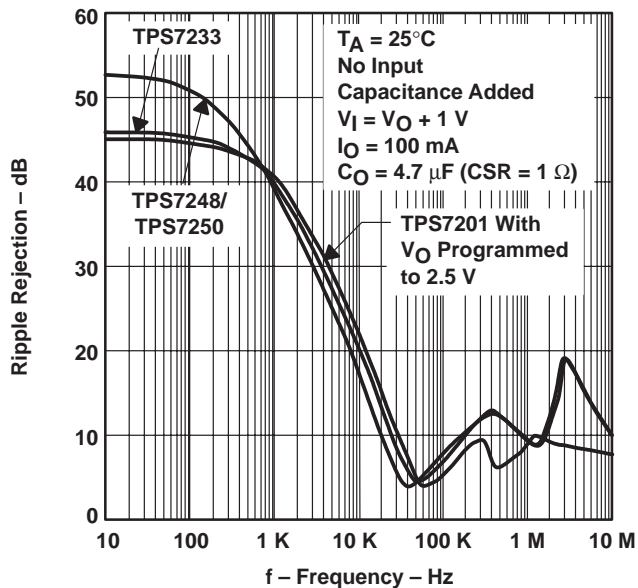

Figure 25

OUTPUT SPECTRAL NOISE DENSITY
 VS
 FREQUENCY

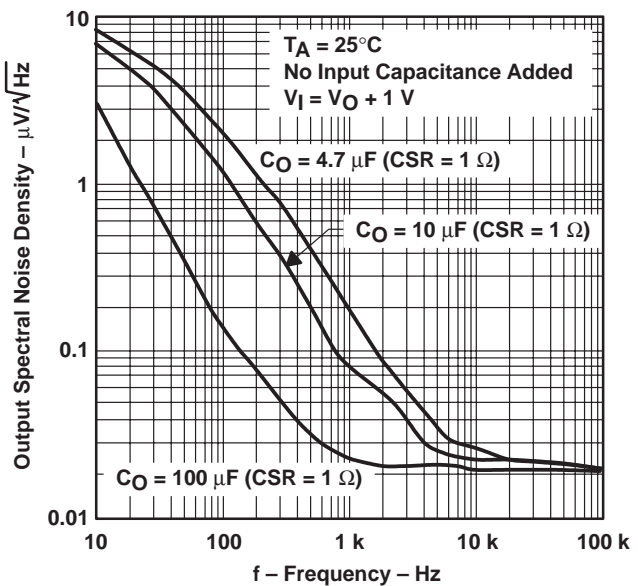

Figure 26

TYPICAL CHARACTERISTICS

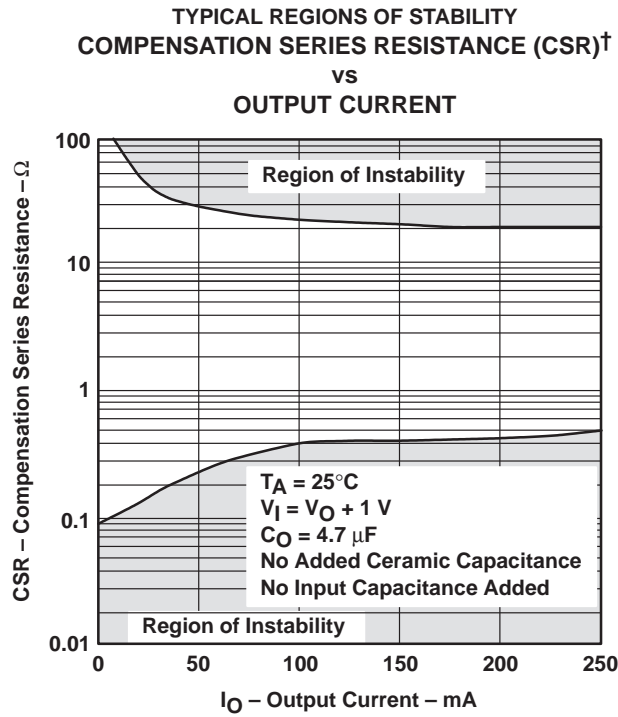

Figure 27

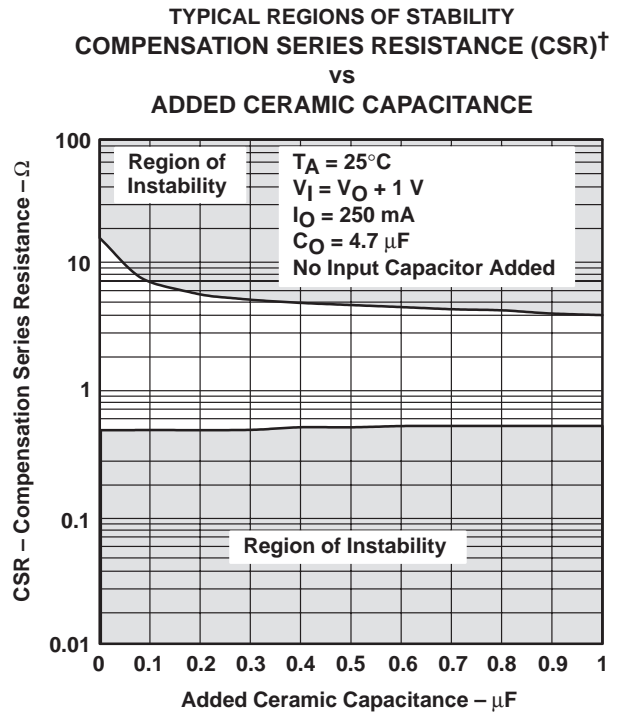

Figure 28

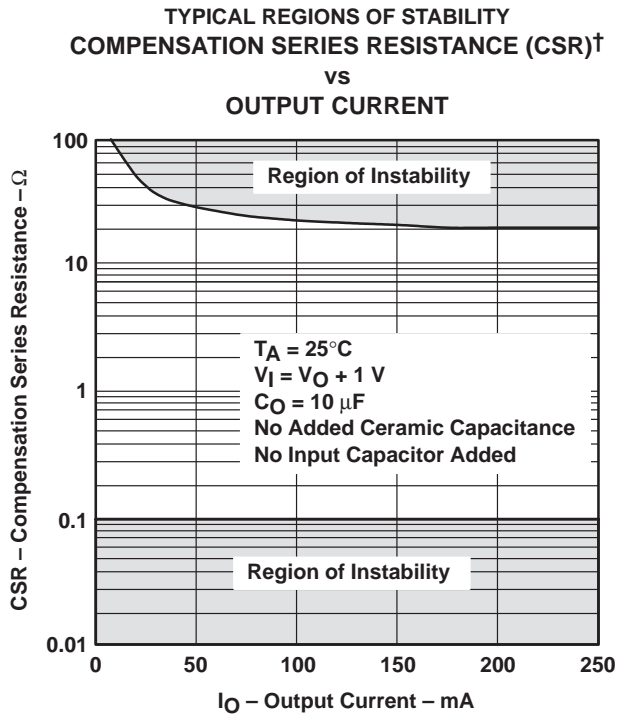

Figure 29

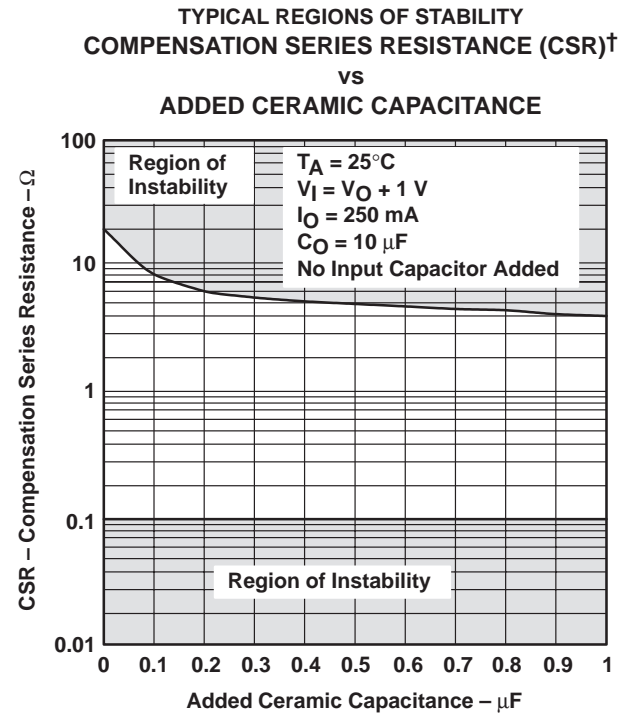

Figure 30

[†] CSR refers to the total series resistance, including the ESR of the capacitor, any series resistance added externally, and PWB trace resistance to C_O .

TPS7201Q, TPS7225Q, TPS7230Q
TPS7233Q, TPS7248Q, TPS7250Q, TPS72xxY
MICROPOWER LOW-DROPOUT (LDO) VOLTAGE REGULATORS

SLVS102G – MARCH 1995 – REVISED JUNE 2000

APPLICATION INFORMATION

The design of the TPS72xx family of low-dropout (LDO) regulators is based on the higher-current TPS71xx family. These new families of regulators have been optimized for use in battery-operated equipment and feature extremely low dropout voltages, low supply currents that remain constant over the full-output-current range of the device, and an enable input to reduce supply currents to less than 0.5 μA when the regulator is turned off.

device operation

The TPS72xx uses a PMOS pass element to dramatically reduce both dropout voltage and supply current over more conventional PNP-pass-element LDO designs. The PMOS transistor is a voltage-controlled device that, unlike a PNP transistor, does not require increased drive current as output current increases. Supply current in the TPS72xx is essentially constant from no-load to maximum.

Current limiting and thermal protection prevent damage by excessive output current and/or power dissipation. The device switches into a constant-current mode at approximately 1 A; further load increases reduce the output voltage instead of increasing the output current. The thermal protection shuts the regulator off if the junction temperature rises above 165°C. Recovery is automatic when the junction temperature drops approximately 5°C below the high temperature trip point. The PMOS pass element includes a back diode that safely conducts reverse current when the input voltage level drops below the output voltage level.

A logic high on the enable input, $\overline{\text{EN}}$, shuts off the output and reduces the supply current to less than 0.5 μA . $\overline{\text{EN}}$ should be grounded in applications where the shutdown feature is not used.

Power good (PG) is an open-drain output signal used to indicate output-voltage status. A comparator circuit continuously monitors the output voltage. When the output drops to approximately 95% of its nominal regulated value, the comparator turns on and pulls PG low.

Transient loads or line pulses can also cause activation of PG if proper care is not taken in selecting the input and output capacitors. Load transients that are faster than 5 μs can cause a signal on PG if high-ESR output capacitors (greater than approximately 7 Ω) are used. A 1- μs transient causes a PG signal when using an output capacitor with greater than 3.5 Ω of ESR. It is interesting to note that the output-voltage spike during the transient can drop well below the reset threshold and still not trip if the transient duration is short. A 1- μs transient must drop at least 500 mV below the threshold before tripping the PG circuit. A 2- μs transient trips PG at just 400 mV below the threshold. Lower-ESR output capacitors help by reducing the drop in output voltage during a transient and should be used when fast transients are expected.

A typical application circuit is shown in Figure 31.



APPLICATION INFORMATION

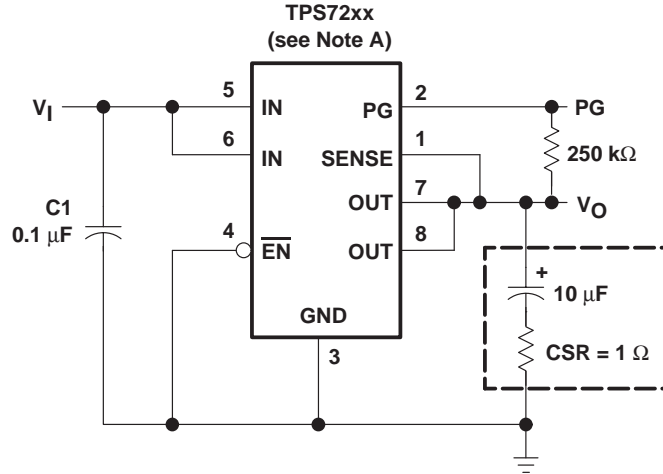

NOTE A: TPS7225, TPS7230, TPS7233, TPS7248, TPS7250
 (fixed-voltage options).

Figure 31. Typical Application Circuit

external capacitor requirements

Although not required, a 0.047- μF to 0.1- μF ceramic bypass input capacitor, connected between IN and GND and located close to the TPS72xx, is recommended to improve transient response and noise rejection. A higher-value electrolytic input capacitor may be necessary if large, fast-rise-time load transients are anticipated and the device is located several inches from the power source.

An output capacitor is required to stabilize the internal feedback loop. For most applications, a 10- μF to 15- μF solid-tantalum capacitor with a 0.5- Ω resistor (see capacitor selection table) in series is sufficient. The maximum capacitor ESR should be limited to 1.3 Ω to allow for ESR doubling at cold temperatures. Figure 32 shows the transient response of a 5-mA to 85-mA load using a 10- μF output capacitor with a total ESR of 1.7 Ω .

A 4.7- μF solid-tantalum capacitor in series with a 1- Ω resistor may also be used (see Figures 27 and 28) provided the ESR of the capacitor does not exceed 1 Ω at room temperature and 2 Ω over the full operating temperature range.

APPLICATION INFORMATION

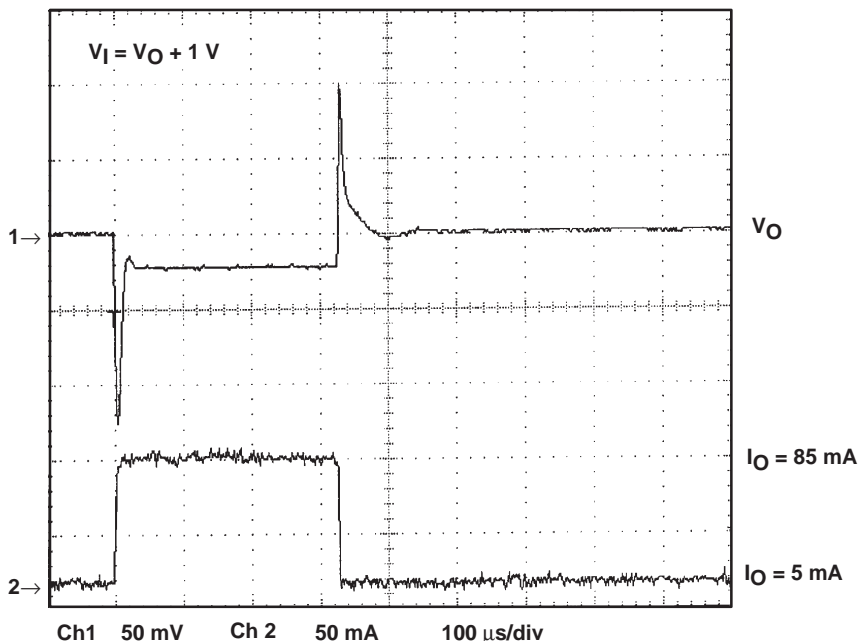

Figure 32. Load Transient Response (CSR total = 1.7 Ω), TPS7248Q

A partial listing of surface-mount capacitors usable with the TPS72xx family is provided below. This information (along with the stability graphs, Figures 27 through 30) is included to assist the designer in selecting suitable capacitors.

CAPACITOR SELECTION

PART NO.	MFR.	VALUE	MAX ESR†	SIZE (H × L × W)†
592D156X0020R2T	Sprague	15 μF, 20 V	1.1	1.2 × 7.2 × 6
595D156X0025C2T	Sprague	15 μF, 25 V	1	2.5 × 7.1 × 3.2
595D106X0025C2T	Sprague	10 μF, 25 V	1.2	2.5 × 7.1 × 3.2
695D106X0035G2T	Sprague	10 μF, 35 V	1.3	2.5 × 7.6 × 2.5

† Size is in mm. ESR is maximum resistance in ohms at 100 kHz and T_A = 25°C. Listings are sorted by height.

sense-pin connection

SENSE must be connected to OUT for proper operation of the regulator. Normally this connection should be as short as possible; however, remote sense may be implemented in critical applications when proper care of the circuit path is exercised. SENSE internally connects to a high-impedance wide-bandwidth amplifier through a resistor-divider network, and any noise pickup on the PCB trace will feed through to the regulator output. SENSE must be routed to minimize noise pickup. Filtering SENSE using an RC network is not recommended because of the possibility of inducing regulator instability.

APPLICATION INFORMATION

output voltage programming

The output voltage of the TPS7201 adjustable regulator is programmed using an external resistor divider as shown in Figure 33. The output voltage is calculated using:

$$V_O = V_{\text{ref}} \cdot \left(1 + \frac{R1}{R2}\right) \quad (1)$$

Where:

$$V_{\text{ref}} = 1.188 \text{ V typ (the internal reference voltage)}$$

Resistors R1 and R2 should be chosen for approximately 7- μA divider current. Lower value resistors can be used but offer no inherent advantage and waste more power. Higher values should be avoided as leakage currents at FB increase the output voltage error. The recommended design procedure is to choose $R2 = 169 \text{ k}\Omega$ to set the divider current at 7 μA and then calculate R1 using:

$$R1 = \left(\frac{V_O}{V_{\text{ref}}} - 1\right) \cdot R2 \quad (2)$$

**OUTPUT VOLTAGE
PROGRAMMING GUIDE**

OUTPUT VOLTAGE (V)	DIVIDER RESISTANCE (k Ω) [†]	
	R1	R2
2.5	191	169
3.3	309	169
3.6	348	169
4	402	169
5	549	169
6.4	750	169

[†] 1% values shown.

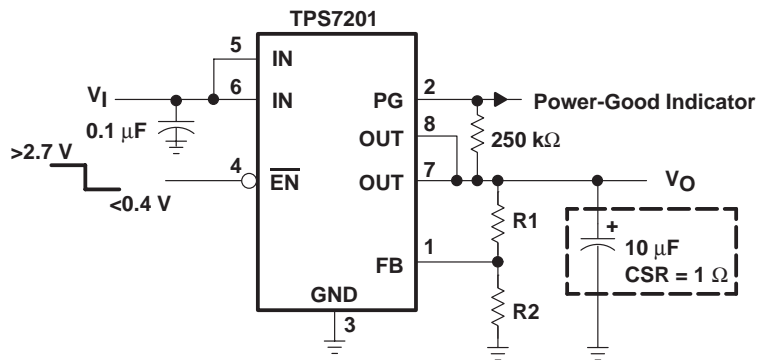

Figure 33. TPS7201 Adjustable LDO Regulator Programming

APPLICATION INFORMATION

power dissipation and junction temperature

Specified regulator operation is assured to a junction temperature of 125°C; the maximum junction temperature allowable to avoid damaging the device is 150°C. These restrictions limit the power dissipation that the regulator can handle in any given application. To ensure the junction temperature is within acceptable limits, calculate the maximum allowable dissipation, $P_{D(max)}$, and the actual dissipation, P_D , which must be less than or equal to $P_{D(max)}$.

The maximum-power-dissipation limit is determined using the following equation:

$$P_{D(max)} = \frac{T_{Jmax} - T_A}{R_{\theta JA}}$$

Where:

T_{Jmax} is the maximum allowable junction temperature, i.e., 150°C absolute maximum and 125°C recommended operating temperature.

$R_{\theta JA}$ is the thermal resistance junction-to-ambient for the package, i.e., 172°C/W for the 8-terminal SOIC and 238°C/W for the 8-terminal TSSOP.

T_A is the ambient temperature.

The regulator dissipation is calculated using:

$$P_D = (V_I - V_O) \cdot I_O$$

Power dissipation resulting from quiescent current is negligible.

regulator protection

The TPS72xx PMOS-pass transistor has a built-in back diode that safely conducts reverse currents when the input voltage drops below the output voltage (e.g., during power down). Current is conducted from the output to the input and is not internally limited. If extended reverse voltage is anticipated, external limiting might be appropriate.

The TPS72xx also features internal current limiting and thermal protection. During normal operation, the TPS72xx limits output current to approximately 1 A. When current limiting engages, the output voltage scales back linearly until the overcurrent condition ends. While current limiting is designed to prevent gross device failure, care should be taken not to exceed the power dissipation ratings of the package. If the temperature of the device exceeds 165°C, thermal-protection circuitry shuts it down. Once the device has cooled, regulator operation resumes.

PACKAGING INFORMATION

Orderable Device	Status (1)	Package Type	Package Drawing	Pins	Package Qty	Eco Plan (2)	Lead/Ball Finish (6)	MSL Peak Temp (3)	Op Temp (°C)	Device Marking (4/5)	Samples
TPS7201QD	ACTIVE	SOIC	D	8	75	Green (RoHS & no Sb/Br)	CU NIPDAU	Level-1-260C-UNLIM	-40 to 125	7201Q	Samples
TPS7201QDG4	ACTIVE	SOIC	D	8		TBD	Call TI	Call TI	-40 to 125		Samples
TPS7201QDR	ACTIVE	SOIC	D	8	2500	Green (RoHS & no Sb/Br)	CU NIPDAU	Level-1-260C-UNLIM	-40 to 125	7201Q	Samples
TPS7201QDRG4	ACTIVE	SOIC	D	8	2500	Green (RoHS & no Sb/Br)	CU NIPDAU	Level-1-260C-UNLIM	-40 to 125	7201Q	Samples
TPS7201QP	ACTIVE	PDIP	P	8	50	Pb-Free (RoHS)	CU NIPDAU	N / A for Pkg Type	-40 to 125	TPS7201QP	Samples
TPS7201QPW	ACTIVE	TSSOP	PW	8	150	Green (RoHS & no Sb/Br)	CU NIPDAU	Level-1-260C-UNLIM	-40 to 125	PT7201	Samples
TPS7201QPWG4	ACTIVE	TSSOP	PW	8	150	Green (RoHS & no Sb/Br)	CU NIPDAU	Level-1-260C-UNLIM	-40 to 125	PT7201	Samples
TPS7201QPWR	ACTIVE	TSSOP	PW	8	2000	Green (RoHS & no Sb/Br)	CU NIPDAU	Level-1-260C-UNLIM	-40 to 125	PT7201	Samples
TPS7225QD	ACTIVE	SOIC	D	8	75	Green (RoHS & no Sb/Br)	CU NIPDAU	Level-1-260C-UNLIM	-55 to 150	7225Q	Samples
TPS7225QDG4	ACTIVE	SOIC	D	8	75	Green (RoHS & no Sb/Br)	CU NIPDAU	Level-1-260C-UNLIM	-55 to 150	7225Q	Samples
TPS7225QDR	ACTIVE	SOIC	D	8	2500	Green (RoHS & no Sb/Br)	CU NIPDAU	Level-1-260C-UNLIM	-55 to 150	7225Q	Samples
TPS7225QDRG4	ACTIVE	SOIC	D	8	2500	Green (RoHS & no Sb/Br)	CU NIPDAU	Level-1-260C-UNLIM	-55 to 150	7225Q	Samples
TPS7225QP	ACTIVE	PDIP	P	8	50	Pb-Free (RoHS)	CU NIPDAU	N / A for Pkg Type	-55 to 150	TPS7225QP	Samples
TPS7225QPWR	ACTIVE	TSSOP	PW	8	2000	Green (RoHS & no Sb/Br)	CU NIPDAU	Level-1-260C-UNLIM	-55 to 150	PT7225	Samples
TPS7230QD	ACTIVE	SOIC	D	8	75	Green (RoHS & no Sb/Br)	CU NIPDAU	Level-1-260C-UNLIM	-55 to 150	7230Q	Samples
TPS7230QP	ACTIVE	PDIP	P	8	50	Pb-Free (RoHS)	CU NIPDAU	N / A for Pkg Type	-40 to 125	TPS7230QP	Samples
TPS7230QPWR	ACTIVE	TSSOP	PW	8	2000	Green (RoHS & no Sb/Br)	CU NIPDAU	Level-1-260C-UNLIM	-40 to 125	PT7230	Samples

Orderable Device	Status (1)	Package Type	Package Drawing	Pins	Package Qty	Eco Plan (2)	Lead/Ball Finish (6)	MSL Peak Temp (3)	Op Temp (°C)	Device Marking (4/5)	Samples
TPS7233QD	ACTIVE	SOIC	D	8	75	Green (RoHS & no Sb/Br)	CU NIPDAU	Level-1-260C-UNLIM	-40 to 125	7233Q	Samples
TPS7233QDG4	ACTIVE	SOIC	D	8	75	Green (RoHS & no Sb/Br)	CU NIPDAU	Level-1-260C-UNLIM	-40 to 125	7233Q	Samples
TPS7233QDR	ACTIVE	SOIC	D	8	2500	Green (RoHS & no Sb/Br)	CU NIPDAU	Level-1-260C-UNLIM	-40 to 125	7233Q	Samples
TPS7233QDRG4	ACTIVE	SOIC	D	8	2500	Green (RoHS & no Sb/Br)	CU NIPDAU	Level-1-260C-UNLIM	-40 to 125	7233Q	Samples
TPS7233QP	ACTIVE	PDIP	P	8	50	Pb-Free (RoHS)	CU NIPDAU	N / A for Pkg Type	-40 to 125	TPS7233QP	Samples
TPS7233QPE4	ACTIVE	PDIP	P	8	50	Pb-Free (RoHS)	CU NIPDAU	N / A for Pkg Type	-40 to 125	TPS7233QP	Samples
TPS7233QPWR	ACTIVE	TSSOP	PW	8	2000	Green (RoHS & no Sb/Br)	CU NIPDAU	Level-1-260C-UNLIM	-40 to 125	PT7233	Samples
TPS7248QD	ACTIVE	SOIC	D	8	75	Green (RoHS & no Sb/Br)	CU NIPDAU	Level-1-260C-UNLIM	-40 to 125	7248Q	Samples
TPS7248QDG4	ACTIVE	SOIC	D	8	75	Green (RoHS & no Sb/Br)	CU NIPDAU	Level-1-260C-UNLIM	-40 to 125	7248Q	Samples
TPS7248QP	ACTIVE	PDIP	P	8	50	Pb-Free (RoHS)	CU NIPDAU	N / A for Pkg Type	-40 to 125	TPS7248QP	Samples
TPS7250QD	ACTIVE	SOIC	D	8	75	Green (RoHS & no Sb/Br)	CU NIPDAU	Level-1-260C-UNLIM	-40 to 125	7250Q	Samples
TPS7250QDG4	ACTIVE	SOIC	D	8	75	Green (RoHS & no Sb/Br)	CU NIPDAU	Level-1-260C-UNLIM	-40 to 125	7250Q	Samples
TPS7250QDR	ACTIVE	SOIC	D	8	2500	Green (RoHS & no Sb/Br)	CU NIPDAU	Level-1-260C-UNLIM	-40 to 125	7250Q	Samples
TPS7250QDRG4	ACTIVE	SOIC	D	8	2500	Green (RoHS & no Sb/Br)	CU NIPDAU	Level-1-260C-UNLIM	-40 to 125	7250Q	Samples
TPS7250QP	ACTIVE	PDIP	P	8	50	Pb-Free (RoHS)	CU NIPDAU	N / A for Pkg Type	-40 to 125	TPS7250QP	Samples
TPS7250QPWR	ACTIVE	TSSOP	PW	8	2000	Green (RoHS & no Sb/Br)	CU NIPDAU	Level-1-260C-UNLIM	-40 to 125	PT7250	Samples

(1) The marketing status values are defined as follows:

ACTIVE: Product device recommended for new designs.

LIFEBUY: TI has announced that the device will be discontinued, and a lifetime-buy period is in effect.

NRND: Not recommended for new designs. Device is in production to support existing customers, but TI does not recommend using this part in a new design.

PREVIEW: Device has been announced but is not in production. Samples may or may not be available.

OBSOLETE: TI has discontinued the production of the device.

⁽²⁾ Eco Plan - The planned eco-friendly classification: Pb-Free (RoHS), Pb-Free (RoHS Exempt), or Green (RoHS & no Sb/Br) - please check <http://www.ti.com/productcontent> for the latest availability information and additional product content details.

TBD: The Pb-Free/Green conversion plan has not been defined.

Pb-Free (RoHS): TI's terms "Lead-Free" or "Pb-Free" mean semiconductor products that are compatible with the current RoHS requirements for all 6 substances, including the requirement that lead not exceed 0.1% by weight in homogeneous materials. Where designed to be soldered at high temperatures, TI Pb-Free products are suitable for use in specified lead-free processes.

Pb-Free (RoHS Exempt): This component has a RoHS exemption for either 1) lead-based flip-chip solder bumps used between the die and package, or 2) lead-based die adhesive used between the die and leadframe. The component is otherwise considered Pb-Free (RoHS compatible) as defined above.

Green (RoHS & no Sb/Br): TI defines "Green" to mean Pb-Free (RoHS compatible), and free of Bromine (Br) and Antimony (Sb) based flame retardants (Br or Sb do not exceed 0.1% by weight in homogeneous material)

⁽³⁾ MSL, Peak Temp. - The Moisture Sensitivity Level rating according to the JEDEC industry standard classifications, and peak solder temperature.

⁽⁴⁾ There may be additional marking, which relates to the logo, the lot trace code information, or the environmental category on the device.

⁽⁵⁾ Multiple Device Markings will be inside parentheses. Only one Device Marking contained in parentheses and separated by a "~" will appear on a device. If a line is indented then it is a continuation of the previous line and the two combined represent the entire Device Marking for that device.

⁽⁶⁾ Lead/Ball Finish - Orderable Devices may have multiple material finish options. Finish options are separated by a vertical ruled line. Lead/Ball Finish values may wrap to two lines if the finish value exceeds the maximum column width.

Important Information and Disclaimer: The information provided on this page represents TI's knowledge and belief as of the date that it is provided. TI bases its knowledge and belief on information provided by third parties, and makes no representation or warranty as to the accuracy of such information. Efforts are underway to better integrate information from third parties. TI has taken and continues to take reasonable steps to provide representative and accurate information but may not have conducted destructive testing or chemical analysis on incoming materials and chemicals. TI and TI suppliers consider certain information to be proprietary, and thus CAS numbers and other limited information may not be available for release.

In no event shall TI's liability arising out of such information exceed the total purchase price of the TI part(s) at issue in this document sold by TI to Customer on an annual basis.

TAPE AND REEL INFORMATION

QUADRANT ASSIGNMENTS FOR PIN 1 ORIENTATION IN TAPE

*All dimensions are nominal

Device	Package Type	Package Drawing	Pins	SPQ	Reel Diameter (mm)	Reel Width W1 (mm)	A0 (mm)	B0 (mm)	K0 (mm)	P1 (mm)	W (mm)	Pin1 Quadrant
TPS7201QDR	SOIC	D	8	2500	330.0	12.4	6.4	5.2	2.1	8.0	12.0	Q1
TPS7201QPWR	TSSOP	PW	8	2000	330.0	12.4	7.0	3.6	1.6	8.0	12.0	Q1
TPS7225QDR	SOIC	D	8	2500	330.0	12.4	6.4	5.2	2.1	8.0	12.0	Q1
TPS7225QPWR	TSSOP	PW	8	2000	330.0	12.4	7.0	3.6	1.6	8.0	12.0	Q1
TPS7230QPWR	TSSOP	PW	8	2000	330.0	12.4	7.0	3.6	1.6	8.0	12.0	Q1
TPS7233QDR	SOIC	D	8	2500	330.0	12.4	6.4	5.2	2.1	8.0	12.0	Q1
TPS7233QPWR	TSSOP	PW	8	2000	330.0	12.4	7.0	3.6	1.6	8.0	12.0	Q1
TPS7250QDR	SOIC	D	8	2500	330.0	12.4	6.4	5.2	2.1	8.0	12.0	Q1
TPS7250QPWR	TSSOP	PW	8	2000	330.0	12.4	7.0	3.6	1.6	8.0	12.0	Q1

TAPE AND REEL BOX DIMENSIONS

*All dimensions are nominal

Device	Package Type	Package Drawing	Pins	SPQ	Length (mm)	Width (mm)	Height (mm)
TPS7201QDR	SOIC	D	8	2500	367.0	367.0	38.0
TPS7201QPWR	TSSOP	PW	8	2000	367.0	367.0	35.0
TPS7225QDR	SOIC	D	8	2500	367.0	367.0	38.0
TPS7225QPWR	TSSOP	PW	8	2000	367.0	367.0	35.0
TPS7230QPWR	TSSOP	PW	8	2000	367.0	367.0	35.0
TPS7233QDR	SOIC	D	8	2500	367.0	367.0	38.0
TPS7233QPWR	TSSOP	PW	8	2000	367.0	367.0	35.0
TPS7250QDR	SOIC	D	8	2500	367.0	367.0	38.0
TPS7250QPWR	TSSOP	PW	8	2000	367.0	367.0	35.0

D (R-PDSO-G8)

PLASTIC SMALL OUTLINE

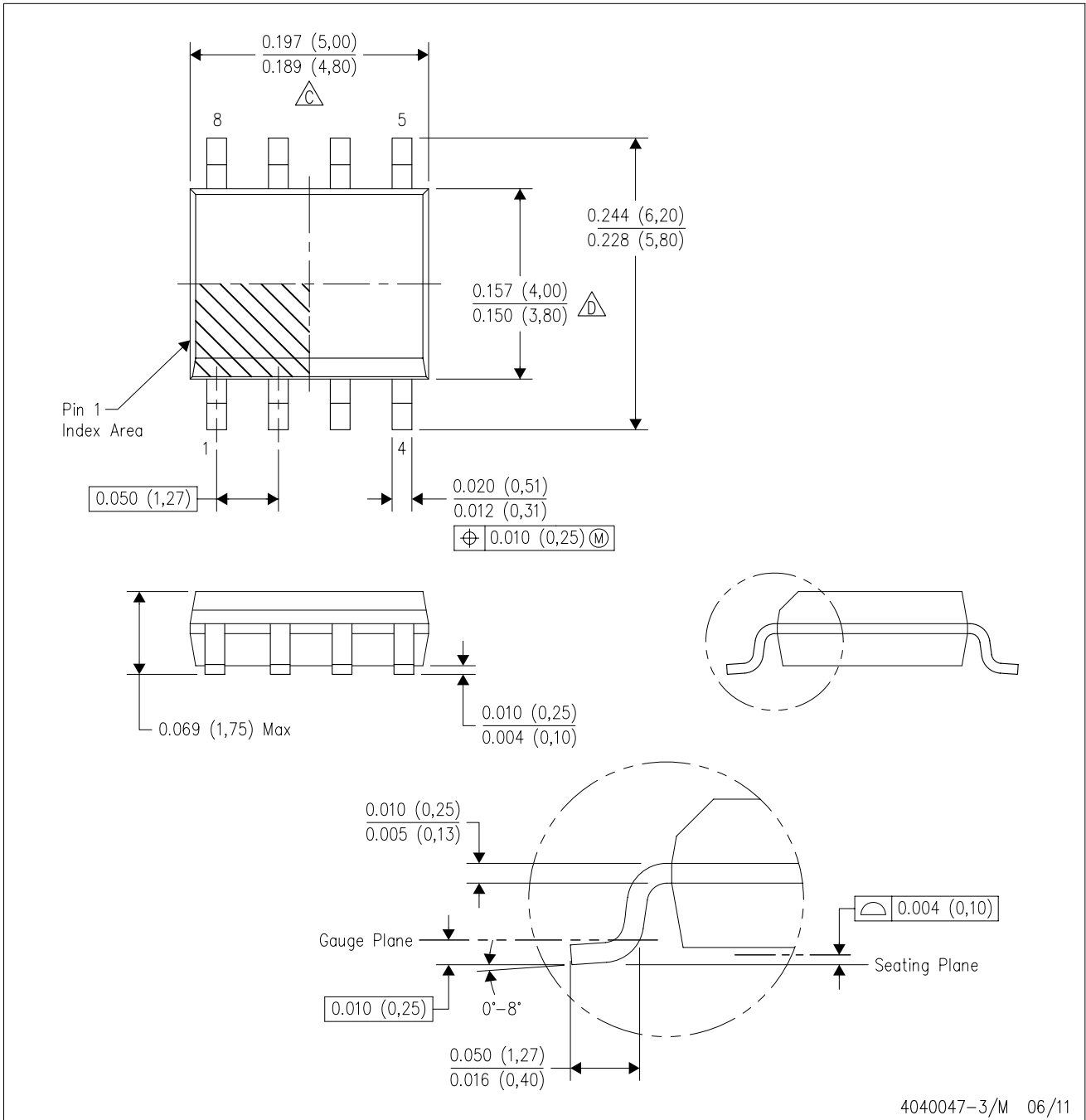

4040047-3/M 06/11

- NOTES:
- A. All linear dimensions are in inches (millimeters).
 - B. This drawing is subject to change without notice.
 - Body length does not include mold flash, protrusions, or gate burrs. Mold flash, protrusions, or gate burrs shall not exceed 0.006 (0,15) each side.
 - Body width does not include interlead flash. Interlead flash shall not exceed 0.017 (0,43) each side.
 - E. Reference JEDEC MS-012 variation AA.

D (R-PDSO-G8)

PLASTIC SMALL OUTLINE



- NOTES:
- A. All linear dimensions are in millimeters.
 - B. This drawing is subject to change without notice.
 - C. Publication IPC-7351 is recommended for alternate designs.
 - D. Laser cutting apertures with trapezoidal walls and also rounding corners will offer better paste release. Customers should contact their board assembly site for stencil design recommendations. Refer to IPC-7525 for other stencil recommendations.
 - E. Customers should contact their board fabrication site for solder mask tolerances between and around signal pads.

P (R-PDIP-T8)

PLASTIC DUAL-IN-LINE PACKAGE



4040082/E 04/2010

- NOTES:
- A. All linear dimensions are in inches (millimeters).
 - B. This drawing is subject to change without notice.
 - C. Falls within JEDEC MS-001 variation BA.

PW0008A



PACKAGE OUTLINE
TSSOP - 1.2 mm max height

SMALL OUTLINE PACKAGE



4221848/A 02/2015

NOTES:

- All linear dimensions are in millimeters. Any dimensions in parenthesis are for reference only. Dimensioning and tolerancing per ASME Y14.5M.
- This drawing is subject to change without notice.
- This dimension does not include mold flash, protrusions, or gate burrs. Mold flash, protrusions, or gate burrs shall not exceed 0.15 mm per side.
- This dimension does not include interlead flash. Interlead flash shall not exceed 0.25 mm per side.
- Reference JEDEC registration MO-153, variation AA.

EXAMPLE BOARD LAYOUT

PW0008A

TSSOP - 1.2 mm max height

SMALL OUTLINE PACKAGE



LAND PATTERN EXAMPLE
SCALE:10X



SOLDER MASK DETAILS
NOT TO SCALE

4221848/A 02/2015

NOTES: (continued)

- 6. Publication IPC-7351 may have alternate designs.
- 7. Solder mask tolerances between and around signal pads can vary based on board fabrication site.

EXAMPLE STENCIL DESIGN

PW0008A

TSSOP - 1.2 mm max height

SMALL OUTLINE PACKAGE



SOLDER PASTE EXAMPLE
BASED ON 0.125 mm THICK STENCIL
SCALE:10X

4221848/A 02/2015

NOTES: (continued)

8. Laser cutting apertures with trapezoidal walls and rounded corners may offer better paste release. IPC-7525 may have alternate design recommendations.
9. Board assembly site may have different recommendations for stencil design.