



# Surface Mount PAR<sup>®</sup> Transient Voltage Suppressors

High Temperature Stability and High Reliability Conditions



DO-214AB (SMC)

### FEATURES

- Junction passivation optimized design passivated anisotropic rectifier technology
- $T_J = 185\text{ }^\circ\text{C}$  capability suitable for high reliability and automotive requirement
- Available in uni-directional polarity only
- 3000 W peak pulse power capability with a 10/1000  $\mu\text{s}$  waveform
- Excellent clamping capability
- Very fast response time
- Low incremental surge resistance
- Meets MSL level 1, per J-STD-020, LF maximum peak of 260  $^\circ\text{C}$
- AEC-Q101 qualified
- Material categorization: for definitions of compliance please see [www.vishay.com/doc?99912](http://www.vishay.com/doc?99912)



RoHS COMPLIANT

PRIMARY CHARACTERISTICS	
$V_{WM}$	10 V to 43 V
$V_{BR}$	11.1 V to 52.8 V
$P_{PPM}$	3000 W
$P_D$	6.0 W
$I_{FSM}$	200 A
$T_J$ max.	185 $^\circ\text{C}$
Polarity	Uni-directional
Package	DO-214AB (SMC)

### TYPICAL APPLICATIONS

Use in sensitive electronics protection against voltage transients induced by inductive load switching and lighting on ICs, MOSFET, signal lines of sensor units for consumer, computer, industrial, automotive, and telecommunication.

### MECHANICAL DATA

**Case:** DO-214AB (SMC)  
Molding compound meets UL 94 V-0 flammability rating  
Base P/NHE3\_X - RoHS-compliant and AEC-Q101 qualified ("X" denotes revision code e.g. A, B, ..., revision code only applicable for part number with  $\pm 5\%$  tolerance)

**Terminals:** matte tin plated leads, solderable per J-STD-002 and JESD 22-B102  
HE3 suffix meets JESD 201 class 2 whisker test

**Polarity:** color band denotes cathode end

MAXIMUM RATINGS ( $T_A = 25\text{ }^\circ\text{C}$ unless otherwise noted)			
PARAMETER	SYMBOL	VALUE	UNIT
Peak pulse power dissipation with a 10/1000 $\mu\text{s}$ waveform <sup>(1)</sup> (fig. 3)	$P_{PPM}$	3000	W
Peak power pulse current with a 10/1000 $\mu\text{s}$ waveform <sup>(1)</sup> (fig. 1)	$I_{PPM}$	See next table	A
Peak forward surge current 8.3 ms single half sine-wave <sup>(2)</sup>	$I_{FSM}$	200	A
Power dissipation on infinite heatsink, $T_L = 75\text{ }^\circ\text{C}$ (fig. 6)	$P_D$	6.0	W
Maximum instantaneous forward voltage at 100 A <sup>(2)</sup>	$V_F$	3.5	V
Operating junction and storage temperature range	$T_J, T_{STG}$	-65 to +185	$^\circ\text{C}$

#### Notes

- <sup>(1)</sup> Non-repetitive current pulse, per fig. 3 and derated above  $T_A = 25\text{ }^\circ\text{C}$  per fig. 2.
- <sup>(2)</sup> Measured on 8.3 ms single half sine-wave, or equivalent square wave, duty cycle = 4 pulses per minute maximum



ELECTRICAL CHARACTERISTICS (T <sub>A</sub> = 25 °C unless otherwise noted)									
DEVICE TYPE	DEVICE MARKING CODE	BREAKDOWN VOLTAGE V <sub>BR</sub> AT I <sub>T</sub> <sup>(1)</sup> (V)		TEST CURRENT I <sub>T</sub> (mA)	STAND-OFF VOLTAGE V <sub>WM</sub> (V)	MAXIMUM REVERSE LEAKAGE AT V <sub>WM</sub> I <sub>R</sub> (μA)	MAXIMUM REVERSE LEAKAGE AT V <sub>WM</sub> I <sub>D</sub> (μA) T <sub>J</sub> = 150 °C	MAXIMUM PEAK PULSE SURGE CURRENT I <sub>PPM</sub> (A) <sup>(2)</sup>	MAXIMUM CLAMPING VOLTAGE AT I <sub>PPM</sub> V <sub>C</sub> (V)
		MIN.	MAX.						
3KASMC10	3AW	11.1	13.6	1.0	10	5.0	50	160	18.8
3KASMC10A	3AX	11.1	12.3	1.0	10	5.0	50	177	17.0
3KASMC11	3AY	12.2	14.9	1.0	11	5.0	50	149	20.1
3KASMC11A	3AZ	12.2	13.5	1.0	11	5.0	50	165	18.2
3KASMC12	3BD	13.3	16.3	1.0	12	2.0	20	136	22.0
3KASMC12A	3BE	13.3	14.7	1.0	12	2.0	20	151	19.9
3KASMC13	3BF	14.4	17.6	1.0	13	2.0	20	126	23.8
3KASMC13A	3BG	14.4	15.9	1.0	13	2.0	20	140	21.5
3KASMC14	3BH	15.6	19.1	1.0	14	1.0	10	116	25.8
3KASMC14A	3BK	15.6	17.2	1.0	14	1.0	10	129	23.2
3KASMC15	3BL	16.7	20.4	1.0	15	1.0	10	112	26.9
3KASMC15A	3BM	16.7	18.5	1.0	15	1.0	10	123	24.4
3KASMC16	3BN	17.8	21.8	1.0	16	1.0	10	104	28.8
3KASMC16A	3BP	17.8	19.7	1.0	16	1.0	10	115	26.0
3KASMC17	3BQ	18.9	23.1	1.0	17	1.0	10	98.4	30.5
3KASMC17A	3BR	18.9	20.9	1.0	17	1.0	10	109	27.6
3KASMC18	3BS	20.0	24.4	1.0	18	1.0	10	93.2	32.2
3KASMC18A	3BT	20.0	22.1	1.0	18	1.0	10	103	29.2
3KASMC20	3BU	22.2	27.1	1.0	20	1.0	10	83.8	35.8
3KASMC20A	3BV	22.2	24.5	1.0	20	1.0	10	92.6	32.4
3KASMC22	3BW	24.4	29.8	1.0	22	1.0	10	76.1	39.4
3KASMC22A	3BX	24.4	26.9	1.0	22	1.0	10	84.5	35.5
3KASMC24	3BY	26.7	32.6	1.0	24	1.0	10	69.8	43.0
3KASMC24A	3BZ	26.7	29.5	1.0	24	1.0	10	77.1	38.9
3KASMC26	3CD	28.9	35.3	1.0	26	1.0	10	64.4	46.6
3KASMC26A	3CE	28.9	31.9	1.0	26	1.0	10	71.3	42.1
3KASMC28	3CF	31.1	38.0	1.0	28	1.0	10	60.0	50.0
3KASMC28A	3CG	31.1	34.4	1.0	28	1.0	10	66.1	45.4
3KASMC30	3CH	33.3	40.7	1.0	30	1.0	15	56.1	53.5
3KASMC30A	3CK	33.3	36.8	1.0	30	1.0	15	62.0	48.4
3KASMC33	3CL	36.7	44.9	1.0	33	1.0	15	50.8	59.0
3KASMC33A	3CM	36.7	40.6	1.0	33	1.0	15	56.3	53.3
3KASMC36	3CN	40.0	48.9	1.0	36	1.0	20	46.7	64.3
3KASMC36A	3CP	40.0	44.2	1.0	36	1.0	20	51.6	58.1
3KASMC40	3CQ	44.4	54.3	1.0	40	1.0	20	42.0	71.4
3KASMC40A	3CR	44.4	49.1	1.0	40	1.0	20	46.5	64.5
3KASMC43	3CS	47.8	58.4	1.0	43	1.0	20	39.1	76.7
3KASMC43A	3CT	47.8	52.8	1.0	43	1.0	20	43.2	69.4

**Notes**

- (1) Pulse test: t<sub>p</sub> ≤ 50 ms  
(2) Surge current waveform per fig. 3 and derate per fig. 2  
(3) All terms and symbols are consistent with ANSI/IEEE C62.35



THERMAL CHARACTERISTICS (T <sub>A</sub> = 25 °C unless otherwise noted)			
PARAMETER	SYMBOL	VALUE	UNIT
Typical thermal resistance, junction to ambient air <sup>(1)</sup>	R <sub>θJA</sub>	77.5	°C/W
Typical thermal resistance, junction to leads	R <sub>θJL</sub>	18.3	

**Note**

<sup>(1)</sup> Mounted on minimum recommended pad layout

ORDERING INFORMATION (Example)				
PREFERRED P/N	UNIT WEIGHT (g)	PREFERRED PACKAGE CODE	BASE QUANTITY	DELIVERY MODE
3KASMC10AHE3_A/H <sup>(1)</sup>	0.211	H	850	7" diameter plastic tape and reel
3KASMC10AHE3_A/I <sup>(1)</sup>	0.211	I	3500	13" diameter plastic tape and reel
3KASMC10AHE3_B/H <sup>(1)</sup>	0.211	H	850	7" diameter plastic tape and reel
3KASMC10AHE3_B/I <sup>(1)</sup>	0.211	I	3500	13" diameter plastic tape and reel

**Note**

<sup>(1)</sup> AEC-Q101 qualified

**RATINGS AND CHARACTERISTICS CURVES (T<sub>A</sub> = 25 °C unless otherwise noted)**

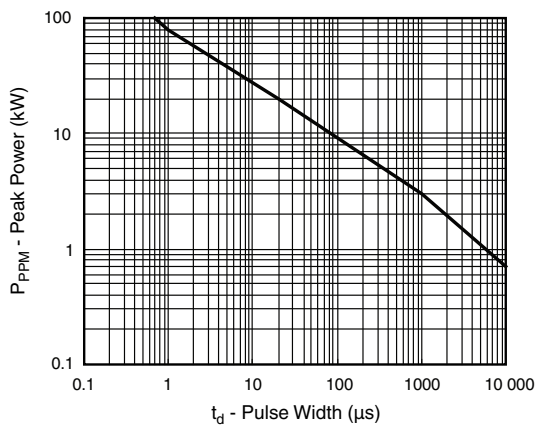

Fig. 1 - Peak Pulse Power Rating Curve

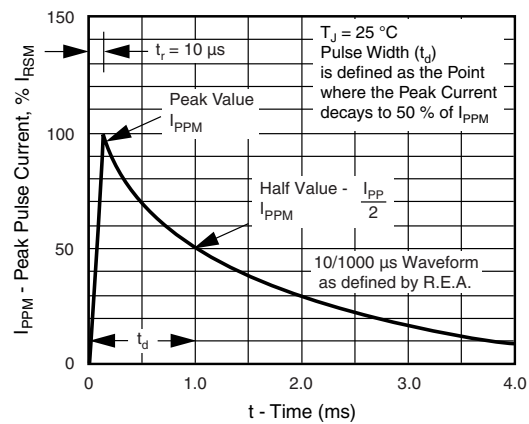

Fig. 3 - Pulse Waveform

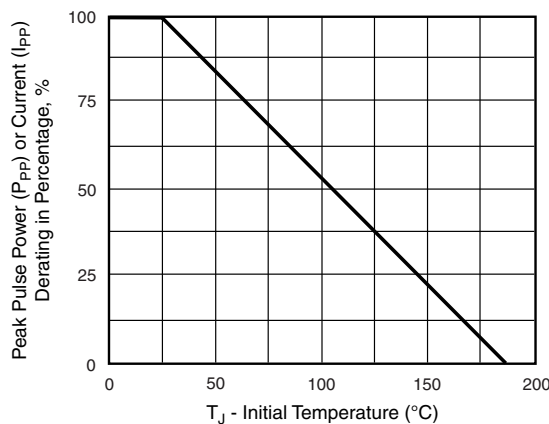

Fig. 2 - Pulse Power or Current vs. Initial Junction Temperature

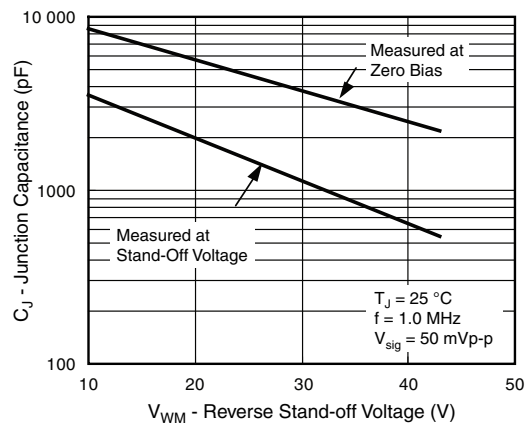

Fig. 4 - Typical Junction Capacitance

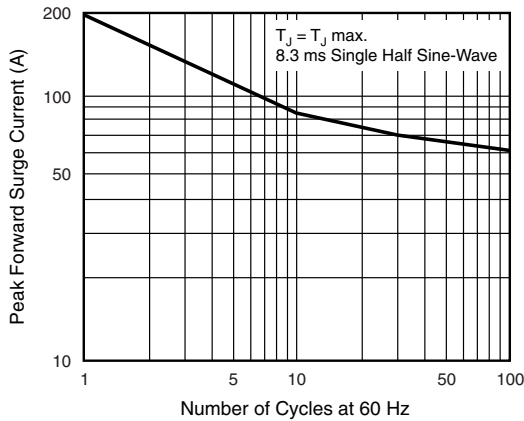

Fig. 5 - Maximum Non-Repetitive/Peak Forward Surge Current

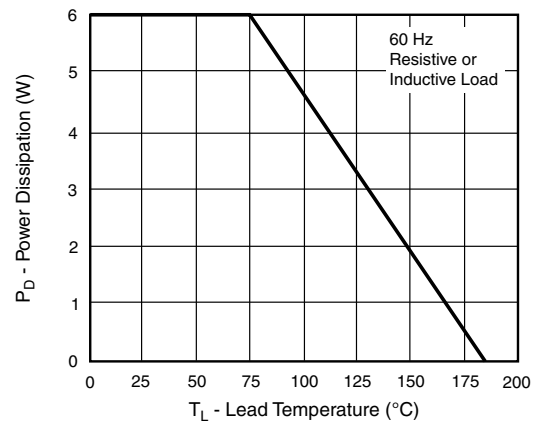
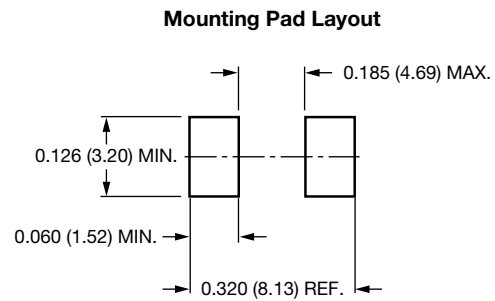
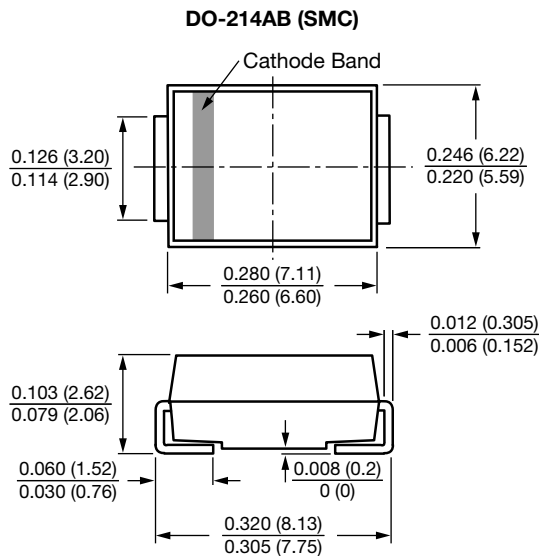

Fig. 6 - Power Derating Curve

## PACKAGE OUTLINE DIMENSIONS in inches (millimeters)





## **Disclaimer**

ALL PRODUCT, PRODUCT SPECIFICATIONS AND DATA ARE SUBJECT TO CHANGE WITHOUT NOTICE TO IMPROVE RELIABILITY, FUNCTION OR DESIGN OR OTHERWISE.

Vishay Intertechnology, Inc., its affiliates, agents, and employees, and all persons acting on its or their behalf (collectively, "Vishay"), disclaim any and all liability for any errors, inaccuracies or incompleteness contained in any datasheet or in any other disclosure relating to any product.

Vishay makes no warranty, representation or guarantee regarding the suitability of the products for any particular purpose or the continuing production of any product. To the maximum extent permitted by applicable law, Vishay disclaims (i) any and all liability arising out of the application or use of any product, (ii) any and all liability, including without limitation special, consequential or incidental damages, and (iii) any and all implied warranties, including warranties of fitness for particular purpose, non-infringement and merchantability.

Statements regarding the suitability of products for certain types of applications are based on Vishay's knowledge of typical requirements that are often placed on Vishay products in generic applications. Such statements are not binding statements about the suitability of products for a particular application. It is the customer's responsibility to validate that a particular product with the properties described in the product specification is suitable for use in a particular application. Parameters provided in datasheets and / or specifications may vary in different applications and performance may vary over time. All operating parameters, including typical parameters, must be validated for each customer application by the customer's technical experts. Product specifications do not expand or otherwise modify Vishay's terms and conditions of purchase, including but not limited to the warranty expressed therein.

Except as expressly indicated in writing, Vishay products are not designed for use in medical, life-saving, or life-sustaining applications or for any other application in which the failure of the Vishay product could result in personal injury or death. Customers using or selling Vishay products not expressly indicated for use in such applications do so at their own risk. Please contact authorized Vishay personnel to obtain written terms and conditions regarding products designed for such applications.

No license, express or implied, by estoppel or otherwise, to any intellectual property rights is granted by this document or by any conduct of Vishay. Product names and markings noted herein may be trademarks of their respective owners.