

Zener Diodes Permitting 500 mW Power Dissipation

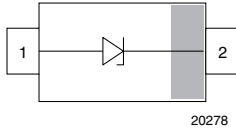

20278

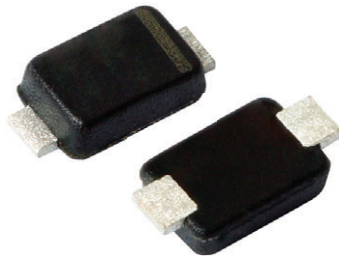

FEATURES

- Silicon planar Zener diodes, ultra small
- Low profile DO-219AC (MicroSMF) package
- Low leakage current
- Excellent stability
- High temperature soldering: 260 °C / 10 s at terminals
- Wave and reflow solderable (reflow as per JPC / JEDEC® J-STD 020) (double wave as per IEC 61760-1)
- AEC-Q101 qualified available
- Base P/N-G3 - RoHS-compliant, green, industrial grade
- Base P/N-HG3 - RoHS-compliant, green, AEC-Q101 qualified
- ESD immunity acc. IEC 61000-4-2 acc. to part table
- Surge performance acc. to part table
- Material categorization: for definitions of compliance please see www.vishay.com/doc?99912



PRIMARY CHARACTERISTICS		
PARAMETER	VALUE	UNIT
V_Z range nom.	2.0 to 39	V
Test current I_{ZT}	5 to 20	mA
V_Z specification	Pulse current	
Int. construction	Single	

ORDERING INFORMATION			
DEVICE NAME	ORDERING CODE	TAPED UNITS PER REEL	MINIMUM ORDER QUANTITY
PLZ-Series	Part number-G3/H	4500 per 7" reel (8 mm tape)	22 500 / box
PLZ-Series	Part number-HG3/H		

PACKAGE				
PACKAGE NAME	WEIGHT	MOLDING COMPOUND FLAMMABILITY RATING	MOISTURE SENSITIVITY LEVEL	SOLDERING CONDITIONS
DO-219AC (MicroSMF)	4.8 mg	UL 94 V-0	MSL level 1 (according J-STD-020)	260 °C / 10 s at terminals

ABSOLUTE MAXIMUM RATINGS ($T_{amb} = 25\text{ °C}$, unless otherwise specified)				
PARAMETER	TEST CONDITION	SYMBOL	VALUE	UNIT
Power dissipation	Mounted on FR4 board 50 mm x 50 mm x 1.6 mm, solder land 10 mm x 10 mm, $T_{amb} = 85\text{ °C}$	P_{tot}	500	mW
Power dissipation	Mounted on FR4 board 50 mm x 50 mm x 1.6 mm, solder land 10 mm x 10 mm, $T_{amb} = 25\text{ °C}$	P_{tot}	960	
Power dissipation	Mounted on FR4 board with recommended soldering footpads (reflow)	P_{tot}	340	
Non-repetitive peak surge power dissipation	$t_p = 8/20\ \mu\text{s}$ acc. IEC 61000-4-5 (PLZ5V1A to PLZ39D)	P_{ZSM}	100	W
	$t_p = 8/20\ \mu\text{s}$ acc. IEC 61000-4-5 (PLZ2V0A to PLZ4V7C)	P_{ZSM}	70	W
Z-current		I_Z	P_{tot}/V_Z	mA
Junction temperature		T_j	150	°C
Storage temperature range		T_{stg}	-55 to +150	

THERMAL CHARACTERISTICS ($T_{amb} = 25\text{ °C}$, unless otherwise specified)				
PARAMETER	TEST CONDITION	SYMBOL	VALUE	UNIT
Typ. thermal resistance junction to ambient air	Mounted on FR4 board 50 mm x 50 mm x 1.6 mm, solder land 10 mm x 10 mm	R_{thJA}	130	K/W
Typ. thermal resistance junction to lead		R_{thJL}	40	K/W

ELECTRICAL SPECIFICATIONS ($T_{amb} = 25\text{ °C}$, unless otherwise specified)						
PARAMETER	TEST CONDITION	SYMBOL	MIN.	TYP.	MAX.	UNIT
Forward Voltage	$I_F = 10\text{ mA}$	V_F		0.8	0.9	V



ELECTRICAL CHARACTERISTICS (T _{amb} = 25 °C, unless otherwise specified)										
PART NUMBER	MARKING CODE	ZENER VOLTAGE RANGE ⁽¹⁾		TEST CURRENT	REVERSE CURRENT		DYNAMIC RESISTANCE	PEAK PULSE CURRENT ⁽²⁾	REVERSE CLAMPING VOLTAGE AT I _{PPM}	ESD IMMUNITY ⁽³⁾
		V _Z at I _{ZT}		I _{ZT1}	I _R at V _R		Z _Z at I _{ZT}	I _{PPM}	V _C	V _{ESD}
		V		mA	μA	V	Ω	A	V	kV
		MIN.	MAX.		MAX.		MAX.		MAX.	MAX.
PLZ2V0A	2A0	1.88	2.10	20	120	0.5	140	12.4	5.65	20
PLZ2V0B	2B0	2.02	2.20	20				12.2	5.71	20
PLZ2V2A	2A2	2.12	2.30	20	120	0.7	120	12.1	5.76	20
PLZ2V2B	2B2	2.22	2.41	20				12.1	5.77	20
PLZ2V4A	2A4	2.33	2.52	20	120	1.0	100	12.1	5.78	≥ 30
PLZ2V4B	2B4	2.43	2.63	20				12.1	5.79	≥ 30
PLZ2V7A	2A7	2.54	2.75	20	100	1.0	100	11.8	5.91	≥ 30
PLZ2V7B	2B7	2.69	2.91	20				11.7	5.98	≥ 30
PLZ3V0A	3A0	2.85	3.07	20	20	1.0	80	11.6	6.02	≥ 30
PLZ3V0B	3B0	3.01	3.22	20				11.3	6.18	≥ 30
PLZ3V3A	3A3	3.16	3.38	20	10	1.0	70	11.2	6.22	≥ 30
PLZ3V3B	3B3	3.32	3.53	20				11.1	6.29	≥ 30
PLZ3V6A	3A6	3.455	3.695	20	5	1.0	60	10.9	6.40	≥ 30
PLZ3V6B	3B6	3.60	3.845	20				10.8	6.47	≥ 30
PLZ3V9A	3A9	3.74	4.10	20	5	1.0	50	10.7	6.54	≥ 30
PLZ3V9B	3B9	3.89	4.16	20				10.6	6.60	≥ 30
PLZ4V3A	4A3	4.04	4.29	20	5	1.0	40	10.5	6.66	≥ 30
PLZ4V3B	4B3	4.17	4.43	20				10.4	6.73	≥ 30
PLZ4V3C	4C3	4.30	4.57	20				10.3	6.80	≥ 30
PLZ4V7A	4A7	4.44	4.68	20	5	1.0	25	10.1	6.93	≥ 30
PLZ4V7B	4B7	4.55	4.80	20				9.9	7.06	≥ 30
PLZ4V7C	4C7	4.68	4.93	20				9.4	7.40	≥ 30
PLZ5V1A	5A1	4.81	5.07	20	5	1.5	20	12.3	8.14	≥ 30
PLZ5V1B	5B1	4.94	5.20	20				12.1	8.23	≥ 30
PLZ5V1C	5C1	5.09	5.37	20				11.9	8.40	≥ 30
PLZ5V6A	5A6	5.28	5.55	20	5	2.5	13	11.6	8.61	≥ 30
PLZ5V6B	5B6	5.45	5.73	20				11.3	8.82	≥ 30
PLZ5V6C	5C6	5.61	5.91	20				11.1	8.99	≥ 30
PLZ6V2A	6A2	5.78	6.09	20	5	3.0	10	10.7	9.32	≥ 30
PLZ6V2B	6B2	5.96	6.27	20				10.5	9.45	≥ 30
PLZ6V2C	6C2	6.12	6.44	20				10.3	9.66	≥ 30
PLZ6V8A	6A8	6.29	6.63	20	2	3.5	8	9.7	10.29	≥ 30
PLZ6V8B	6B8	6.49	6.83	20				9.5	10.50	≥ 30
PLZ6V8C	6C8	6.66	7.01	20				9.4	10.60	≥ 30
PLZ7V5A	7A5	6.85	7.22	20	0.5	4.0	8	9.0	11.06	≥ 30
PLZ7V5B	7B5	7.07	7.45	20				8.8	11.34	≥ 30
PLZ7V5C	7C5	7.29	7.67	20				8.6	11.54	≥ 30
PLZ8V2A	8A2	7.53	7.92	20	0.5	5.0	8	8.4	11.80	≥ 30
PLZ8V2B	8B2	7.78	8.19	20				8.3	12.00	≥ 30
PLZ8V2C	8C2	8.03	8.45	20				7.9	12.60	≥ 30
PLZ9V1A	9A1	8.29	8.73	20	0.5	6.0	8	7.8	12.86	≥ 30
PLZ9V1B	9B1	8.57	9.01	20				7.6	13.17	≥ 30
PLZ9V1C	9C1	8.83	9.30	20				7.4	13.55	≥ 30

Notes

- (1) Pulse test: t_p = 40 ms
- (2) Pulse test: t_p = 8/20 μs acc. IEC 61000-4-5
- (3) Contact and air discharge acc. IEC 61000-4-2



ELECTRICAL CHARACTERISTICS (T _{amb} = 25 °C, unless otherwise specified)										
PART NUMBER	MARKING CODE	ZENER VOLTAGE RANGE ⁽¹⁾		TEST CURRENT	REVERSE CURRENT		DYNAMIC RESISTANCE	PEAK PULSE CURRENT ⁽²⁾	REVERSE CLAMPING VOLTAGE AT I _{PPM}	ESD IMMUNITY ⁽³⁾
		V _Z at I _{ZT}		I _{ZT1}	I _R at V _R		Z _Z at I _{ZT}	I _{PPM}	V _C	V _{ESD}
		V		mA	μA	V	Ω	A	V	kV
		MIN.	MAX.		MAX.		MAX.		MAX.	MAX.
PLZ10A	10A	9.12	9.59	20	0.2	7.0	8	7.09	14.1	≥ 30
PLZ10B	10B	9.41	9.90	20				6.90	14.5	≥ 30
PLZ10C	10C	9.70	10.20	20				6.75	14.8	≥ 30
PLZ10D	10D	9.94	10.44	20				6.58	15.2	≥ 30
PLZ11A	11A	10.18	10.71	10	0.2	8.0	10	6.47	15.5	≥ 30
PLZ11B	11B	10.50	11.05	10				6.25	16.0	≥ 30
PLZ11C	11C	10.82	11.38	10				6.10	16.4	≥ 30
PLZ12A	12A	11.13	11.71	10	0.2	9.0	12	5.95	16.8	≥ 30
PLZ12B	12B	11.44	12.03	10				5.80	17.2	≥ 30
PLZ12C	12C	11.74	12.35	10				5.43	18.4	≥ 30
PLZ13A	13A	12.11	12.75	10	0.2	10	14	5.29	18.9	≥ 30
PLZ13B	13B	12.55	13.21	10				5.15	19.4	≥ 30
PLZ13C	13C	12.99	13.66	10				5.05	19.8	≥ 30
PLZ15A	15A	13.44	14.13	10	0.2	11	16	4.93	20.3	≥ 30
PLZ15B	15B	13.89	14.62	10				4.76	21.0	≥ 30
PLZ15C	15C	14.35	15.09	10				4.50	22.0	≥ 30
PLZ16A	16A	14.80	15.57	10	0.2	12	18	4.25	23.5	≥ 30
PLZ16B	16B	15.25	16.04	10				4.18	23.9	≥ 30
PLZ16C	16C	15.69	16.51	10				3.96	25.2	≥ 30
PLZ18A	18A	16.22	17.06	10	0.2	13	23	3.95	25.3	≥ 30
PLZ18B	18B	16.82	17.70	10				3.77	26.5	≥ 30
PLZ18C	18C	17.42	18.33	10				3.69	27.1	≥ 30
PLZ20A	20A	18.02	18.96	10	0.2	15	28	3.43	29.1	≥ 30
PLZ20B	20B	18.63	19.59	10				3.40	29.4	≥ 30
PLZ20C	20C	19.23	20.22	10				3.33	30.0	≥ 30
PLZ20D	20D	19.72	20.72	10				3.18	31.4	≥ 30
PLZ22A	22A	20.15	21.20	5	0.2	17	30	3.13	31.9	≥ 30
PLZ22B	22B	20.64	21.71	5				3.07	32.6	≥ 30
PLZ22C	22C	21.08	22.17	5				2.82	35.4	25
PLZ22D	22D	21.52	22.63	5				2.80	35.6	25
PLZ24A	24A	22.05	23.18	5	0.2	19	35	2.77	36.1	25
PLZ24B	24B	22.61	23.77	5				2.70	37.0	25
PLZ24C	24C	23.12	24.31	5				2.64	37.8	25
PLZ24D	24D	23.63	24.85	5				2.61	38.3	25
PLZ27A	27A	24.26	25.52	5	0.2	21	45	2.55	39.2	25
PLZ27B	27B	24.97	26.26	5				2.49	40.1	25
PLZ27C	27C	25.63	26.95	5				2.32	43.0	20
PLZ27D	27D	26.29	27.64	5				2.30	43.5	20

Notes

- (1) Pulse test: t_p = 40 ms
- (2) Pulse test: t_p = 8/20 μs acc. IEC 61000-4-5
- (3) Contact and air discharge acc. IEC 61000-4-2



ELECTRICAL CHARACTERISTICS ($T_{amb} = 25\text{ }^{\circ}\text{C}$, unless otherwise specified)

PART NUMBER	MARKING CODE	ZENER VOLTAGE RANGE ⁽¹⁾		TEST CURRENT	REVERSE CURRENT		DYNAMIC RESISTANCE	PEAK PULSE CURRENT ⁽²⁾	REVERSE CLAMPING VOLTAGE AT I_{PPM}	ESD IMMUNITY ⁽³⁾
		V_Z at I_{ZT}		I_{ZT1}	I_R at V_R		Z_Z at I_{ZT}	I_{PPM}	V_C	V_{ESD}
		V		mA	μA	V	Ω	A	V	kV
		MIN.	MAX.		MAX.		MAX.		MAX.	MAX.
PLZ30A	30A	26.99	28.39	5	0.2	23	55	2.28	43.7	20
PLZ30B	30B	27.70	29.13	5				2.21	45.2	20
PLZ30C	30C	28.36	29.82	5				2.21	45.5	20
PLZ30D	30D	29.02	30.51	5				2.20	46.3	20
PLZ33A	33A	29.68	31.22	5	0.2	25	65	2.10	47.6	20
PLZ33B	33B	30.32	31.88	5				1.94	51.6	15
PLZ33C	33C	30.90	32.50	5				1.91	52.2	15
PLZ33D	33D	31.49	33.11	5				1.91	52.2	15
PLZ36A	36A	32.14	33.79	5	0.2	27	75	1.88	53.1	15
PLZ36B	36B	32.79	34.49	5				1.78	55.9	15
PLZ36C	36C	33.40	35.13	5				1.76	56.7	15
PLZ36D	36D	34.01	35.77	5				1.75	56.9	15
PLZ39A	39A	34.68	36.47	5	0.2	30	85	1.74	57.2	15
PLZ39B	39B	35.36	37.19	5				1.74	57.4	15
PLZ39C	39C	36.00	37.85	5				1.70	58.7	15
PLZ39D	39D	36.63	38.20	5				1.67	59.9	15

Notes

- (1) Pulse test: $t_p = 40\text{ ms}$
- (2) Pulse test: $t_p = 8/20\text{ }\mu\text{s acc. IEC 61000-4-5}$
- (3) Contact and air discharge acc. IEC 61000-4-2

TYPICAL CHARACTERISTICS ($T_{amb} = 25\text{ }^{\circ}\text{C}$, unless otherwise specified)

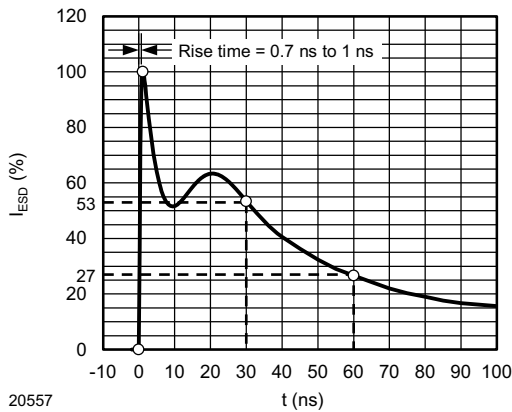

Fig. 1 - ESD Discharge Current Wave Form acc. IEC 61000-4-2 (330 Ω / 150 pF)

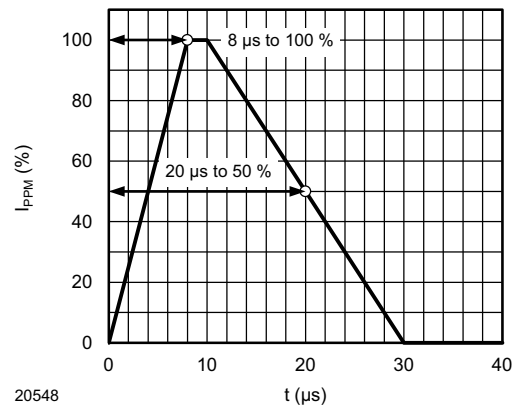
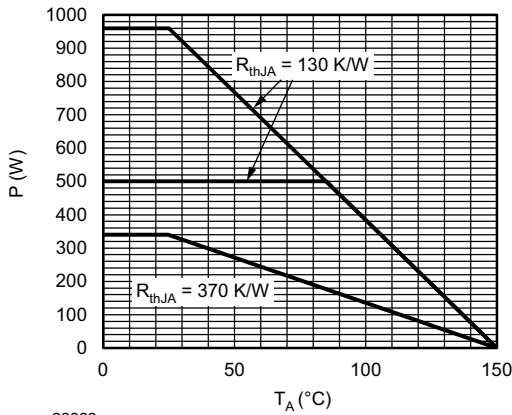
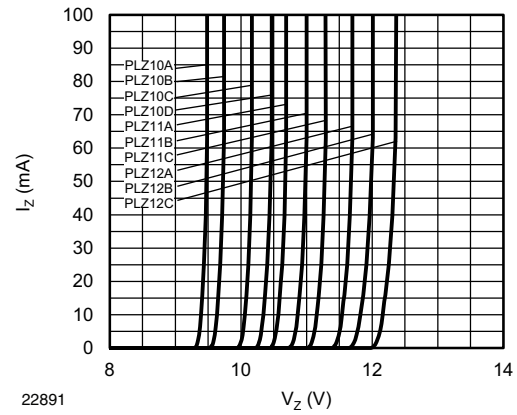

Fig. 2 - 8/20 μs Peak Pulse Current Wave Form acc. IEC 61000-4-5



22888

Fig. 3 - Maximum Power Dissipation vs. Ambient Temperature



22891

Fig. 6 - Breakdown Characteristics

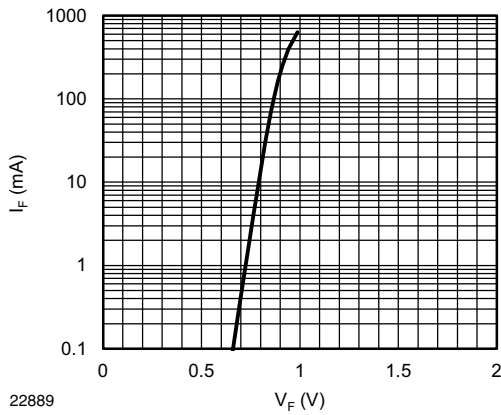

22889

Fig. 4 - Typical Forward Current vs. Forward Voltage

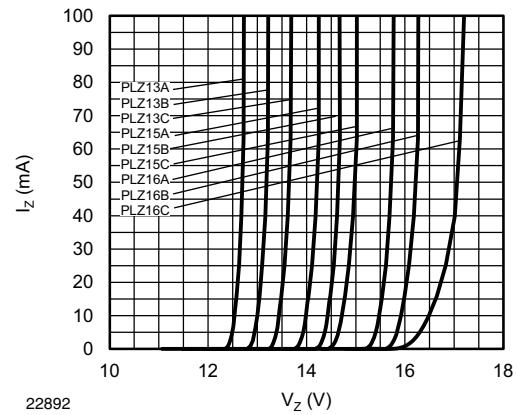

22892

Fig. 7 - Breakdown Characteristics

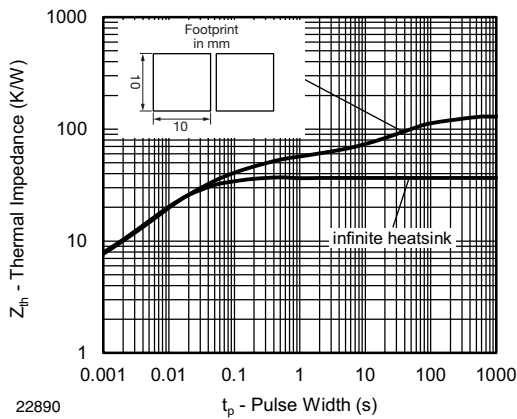

22890

Fig. 5 - Thermal Impedance vs. Time

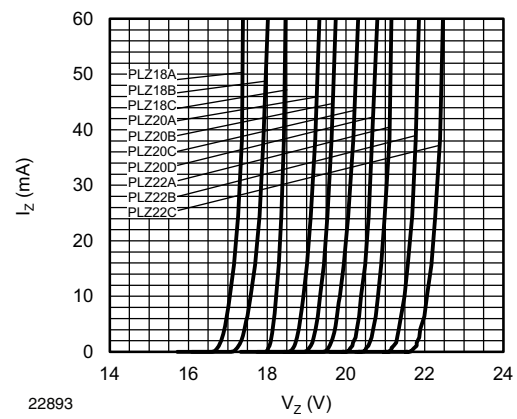

22893

Fig. 8 - Breakdown Characteristics

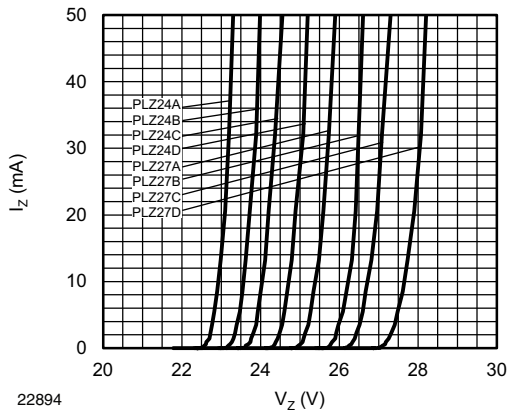

Fig. 9 - Breakdown Characteristics

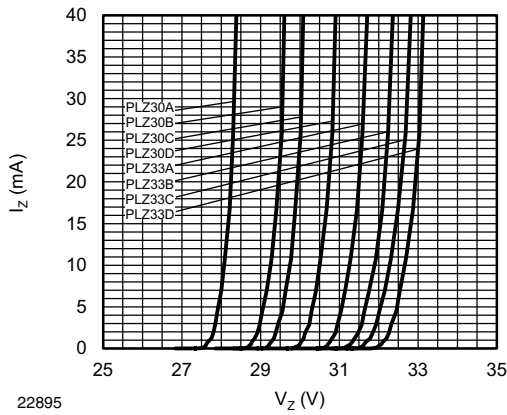

Fig. 10 - Breakdown Characteristics

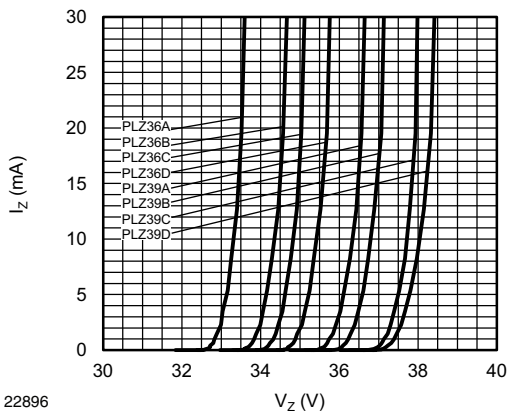
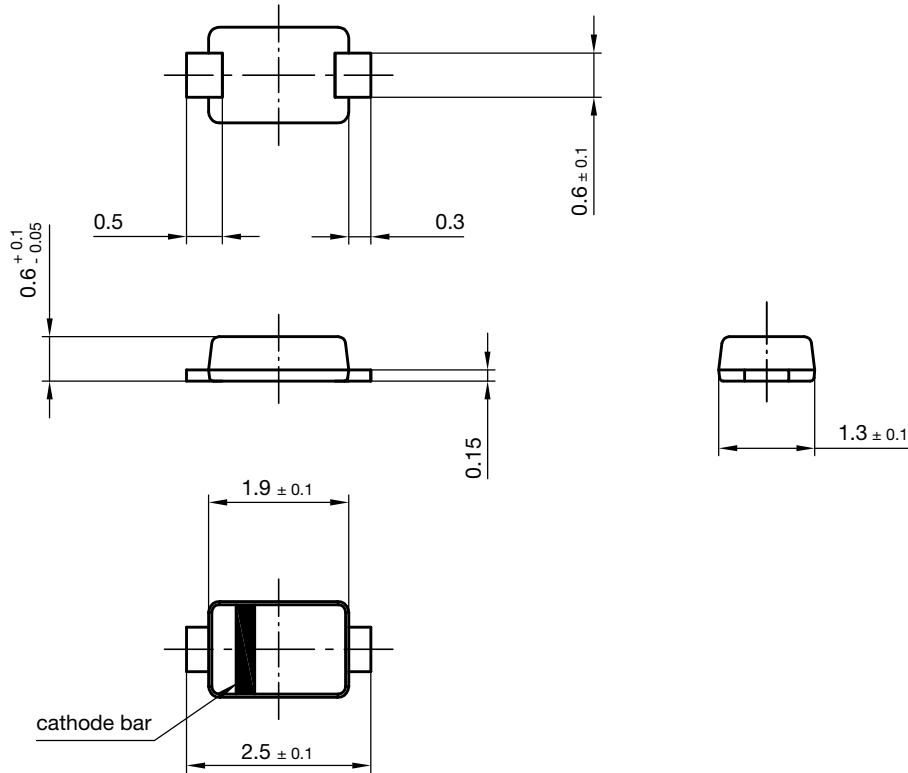

Fig. 11 - Breakdown Characteristics



PACKAGE DIMENSIONS in millimeters: DO-219AC (MicroSMF)



foot print recommendation
for wave soldering:

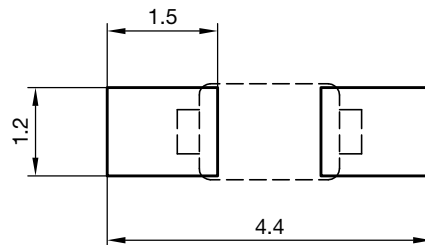

foot print recommendation
for reflow soldering:

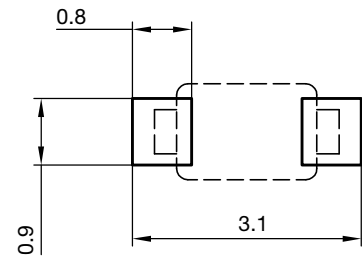

22741

Document no.: S8-V-3910.03-001 (4)
Created - Date: 02.Dec.2010
Rev. 5 - Date: 06.May. 2014

BLISTER TAPE DIMENSIONS in millimeters: DO-219AC (MicroSMF)

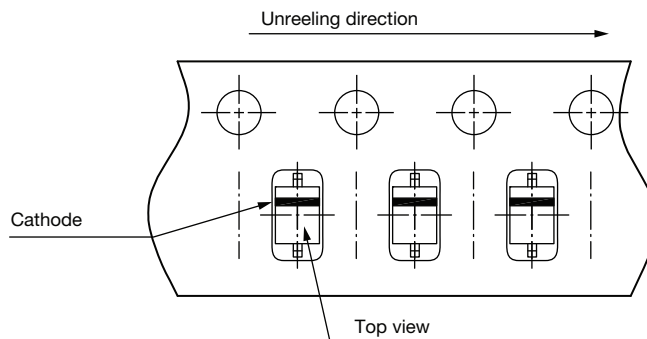
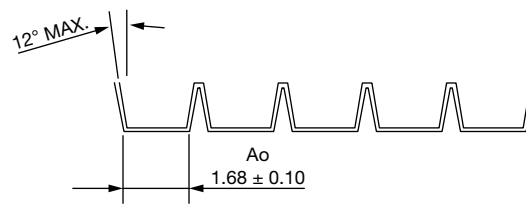
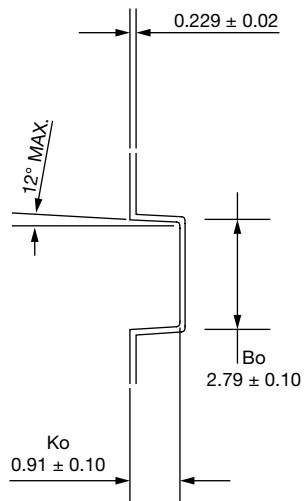
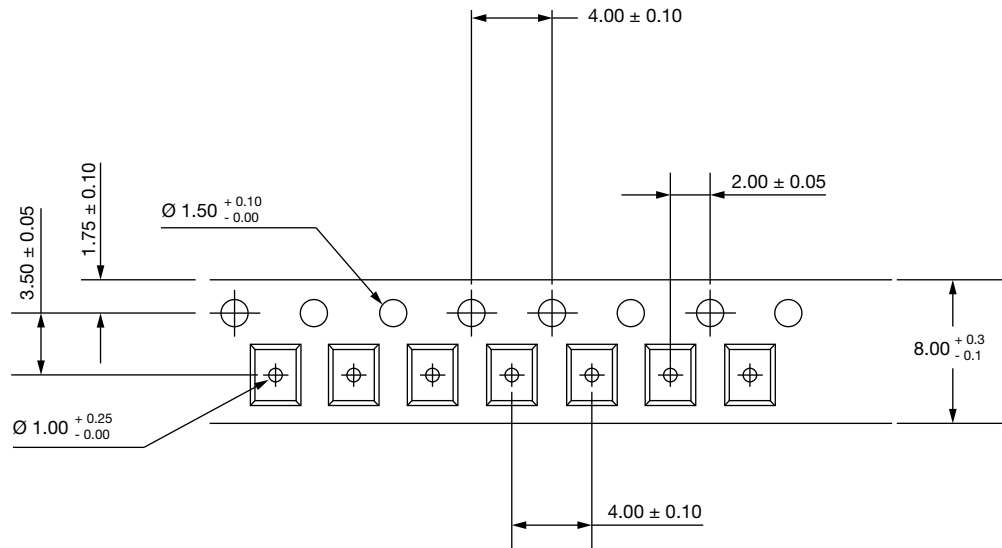



Disclaimer

ALL PRODUCT, PRODUCT SPECIFICATIONS AND DATA ARE SUBJECT TO CHANGE WITHOUT NOTICE TO IMPROVE RELIABILITY, FUNCTION OR DESIGN OR OTHERWISE.

Vishay Intertechnology, Inc., its affiliates, agents, and employees, and all persons acting on its or their behalf (collectively, "Vishay"), disclaim any and all liability for any errors, inaccuracies or incompleteness contained in any datasheet or in any other disclosure relating to any product.

Vishay makes no warranty, representation or guarantee regarding the suitability of the products for any particular purpose or the continuing production of any product. To the maximum extent permitted by applicable law, Vishay disclaims (i) any and all liability arising out of the application or use of any product, (ii) any and all liability, including without limitation special, consequential or incidental damages, and (iii) any and all implied warranties, including warranties of fitness for particular purpose, non-infringement and merchantability.

Statements regarding the suitability of products for certain types of applications are based on Vishay's knowledge of typical requirements that are often placed on Vishay products in generic applications. Such statements are not binding statements about the suitability of products for a particular application. It is the customer's responsibility to validate that a particular product with the properties described in the product specification is suitable for use in a particular application. Parameters provided in datasheets and / or specifications may vary in different applications and performance may vary over time. All operating parameters, including typical parameters, must be validated for each customer application by the customer's technical experts. Product specifications do not expand or otherwise modify Vishay's terms and conditions of purchase, including but not limited to the warranty expressed therein.

Except as expressly indicated in writing, Vishay products are not designed for use in medical, life-saving, or life-sustaining applications or for any other application in which the failure of the Vishay product could result in personal injury or death. Customers using or selling Vishay products not expressly indicated for use in such applications do so at their own risk. Please contact authorized Vishay personnel to obtain written terms and conditions regarding products designed for such applications.

No license, express or implied, by estoppel or otherwise, to any intellectual property rights is granted by this document or by any conduct of Vishay. Product names and markings noted herein may be trademarks of their respective owners.